

Instruction Book

All models 2019 / 2020



This manual belongs to the following boat:

Yard identification Hallberg-Rassy.....
Description GRP Keel sailing yacht
Category A- Unlimited ocean voyages
Test Mode Module B + C for boats from 12 m,
 Aa for boats below 12 m

CIN No.

--	--	--	--	--	--	--	--	--	--	--	--	--	--	--

Recommended maximum load: kg (incl.persons)

WARNING — Do not exceed the maximum recommended number of persons. Regardless of the number of persons on board, the total weight of persons and equipment must never exceed the maximum recommended load. Always use the seats/seating spaces provided.

The maximum recommended load includes the weight of all persons onboard, all provisions and personal effects, any equipment not included in the light craft mass, cargo (if any) and all consumable liquids (water, fuel, etc.)

Keep portlights, windows, washboards, doors, hatches or ventilation openings closed when appropriate, e.g. in rough weather to minimize the risk of flooding. Breaking waves are a serious stability hazard.

Any change in the disposition of the masses aboard (for example the addition of a radar, change of engine, etc.) may significantly affect the stability, trim and performance of the craft.

We at **Hallberg-Rassy** always strive to improve our products. For this reason changes are always possible and are carried out if considered appropriate. All details are given in good faith and are believed to be correct but are not guaranteed.

Copyright© Hallberg-Rassy Varvs AB 1996-2019
Revision date: 6 December, 2019

INDEX

	PAGE		PAGE
Introduction	5		
Emergency exits	6	Safety with 230 V on Board	23
Man overboard recovery	6-7	Use of generator and engine when sailing	24
Engine	8-9	Water system	25-26
Propeller Shaft Seals	9	Refrigeration	27
Sailing propeller	10-11	Heating	27
Water and diesel Tanks	10-11	Toilet	28
Diesel quality	13	Holding Tank	29
Water and diesel	12-13	Manual Bilge pump	29-30
Diesel consumption and range	13	El. Bilge and drain pump	29-30
Drawing of diesel system	14-16	Anchor Windlass	31-32
Mast and rig	17	Bow Thruster	32
Back stay tensioner	17	Liquefied Petroleum Gas system	33-35
Cutter stay	17	Going to sea	35
Sails	19	Compass	35
Batteries and charging	20	Winches	36
Self discharge	21	Sprayhood	36-37
Electric system 12 and 24 v	21-23	Steering	38-40
230 V via shore connection or generator	23	Autopilot	41
230 V via inverter	23	Electronic instruments	41
		Pressure water and fenders	41

Maintenance

Maintenance of the gelcoat surfaces	41	Electrolysis	43
Teak Deck	42	Adjustment of locker hinges	45-47
Oiled teak deck	43	Lifting and Supporting Ashore	48-49
Varnished teak	43	Risk of Freezing	50
Antifouling paint	43	Skin fittings	50-61
Carpets	44	Lay Up or Longer stops	63
Cleaning of tanks, pipes and pumps	44	Short list for winter preparations	64

Further data

Important measurements	64	Important addresses	65
------------------------	----	---------------------	----

Appendix	Engine
	Mast and rig
	Heating
	Refrigeration
	Sails

Category A: This craft is designed to operate in winds that may exceed wind force 8 (Beaufort scale) and in significant wave heights of 4 m and above (see Note 1 below), and is largely self-sufficient. Abnormal conditions such as hurricanes are excluded. Such conditions may be encountered on extended voyages, for example across oceans, or inshore when unsheltered from the wind and waves for several hundred nautical miles.

Note 1: The significant wave height is the mean height of the highest one-third of the waves, which approximately corresponds to the wave height estimated by an experienced observer. Some waves will be double this height.

Compulsory directions according to the EU regulations

This manual has been compiled to help you to operate your craft with safety and pleasure. It contains details of the craft, the equipment supplied or fitted, its systems and information on its operating and maintenance. Please read it carefully, and familiarise yourself with the craft before using it.

If this is your first craft, or if you are changing to a type of craft you are not familiar with, for your own comfort and safety, please ensure that you obtain handling and operating experience before taking command of the craft.

Your dealer or national sailing federation or yacht club will be pleased to advise you of local sea schools, or competent instructors.

Please keep this manual in a secure place and hand it over to the new owner if you sell the craft.

Danger and protection of the environment

In this instruction book you will find three different signs:

Danger!

This sign is used where there can be danger for your life.

Warning !

This sign is used where predictable danger can occur.

Note !

This sign is used where you should be extra careful.

Introduction

The delivery day is a great day, and we wish you good luck with your new **Hallberg-Rassy**.

The delivery day is, however, a busy day when many things are happening. Things are easily missed and sometimes you forget what has been explained.

Danger

All sailing demands good seamanship. To describe what this means is outside the framework of this booklet. We assume you have the knowledge to handle your boat in a way that will not expose yourself or your crew to unnecessary risks.

If you're changing to a type of craft you are not familiar with, please ensure that you obtain handling and operating experience before "taking command" of the craft.

Please remember that safety is nothing that is obtained once for ever. Each skipper continuously has to look after and when necessary update his boat.

Read this booklet carefully! We have tried to present the essential information in a short and easily understood way.

The yachts we build differ in size and equipment. The principles are however fairly similar. You will quickly find out what applies to your boat. The rest you can ignore.

This is the English edition of this manual. It is also available in German and in Swedish.

Fire, flooding and overload

Fire on board is one of the most dangerous situations that can arise on a yacht. Take every measurement to minimise the risk. A fire detector is mounted in the ceiling of the saloon/galley/navigation area. Inform your crew before every departure where to find and how to operate the fire extinguishers and the eventual permanent installed fire equipment for the engine room. Keep exits from the accommodation free!

All boats are equipped with automatic fire extinguishing system for the engine room. The system is activated automatically when the temperature reaches its specific temperature. As standard there is no way to manually start this system. The fire extinguisher is placed in the engine room in a way that the manometer that shows the working pressure can be read. If this pressure is too low, the extinguisher must be exchanged immediately. Please follow the instructions by the manufacturer of the extinguisher.

Risk of Flooding exists if the two valves for the toilet are not kept closed.

Inform everyone on board how to operate the toilets with safety.

Generally speaking: **flush valve on DRY** and **overboard valve CLOSED**.

All other sea valves are normally kept open and are only closed when a leak or other conditions call for it.

Overload

The recommended maximum number of persons on board is stated on the builder's CE sign on aluminium plate in the cockpit. Local or national regulations may stipulate other and specify life saving equipment.

The fold out bathing platforms are designed to carry a maximum static load of 250 kg.

Emergency exits

Each boat has emergency exits labelled "Exit". Ladder to reach aft cabin emergency exit HR 57 and HR 64 is located in the aft bed on the 57 and in the aft hanging locker on the 64. You simply erect the folding ladder to reach the exit.

Man overboard recovery

Do anything you can to avoid that somebody is falling overboard! If that still should happen, each Hallberg-Rassy boat has a bathing ladder on the transom to get on board again. Some models have fold out folding platforms. If you have a powered operation, there is also an emergency button on the transom, reachable from the water level. If you have a 40C with manual platform, you shall put the control line over middle tube of the pushpit, and the open end down to the water in order to be able to access the control rope from the water and consequently be able to fold down the platform from the water in an emergency situation.

When a fold out swim platform is being folded out, keep out of the operating area if you are in the water, to avoid being hit.

Man over board recovery for Hallberg-Rassy 340 or 44 if you have a manual fold out bathing platform is achieved by an extra soft ladder in a bag as per the photo below.



Hooking points / jack lines

As standard you can use the windward side guardrail as hooking point or a cleat at the mast, for jack lines on deck use the mooring cleats or if ordered separate eye bolt.

The engine

Danger !

There are unprotected rotating parts and belts in the engine compartment. Make sure the engine controls are at "STOP" position before commencing any work on the engine to minimise the risk of injury.

The engine manufacturer manual is found at the end of this book.

Engine break-in and running:

More engines are damaged by slow running and by rust caused from poor winterising at lay up than overloading or due to many operating hours.

There is no reason to be over-cautious during the running in period. All revs between 1800 and 2600 RPM are acceptable. You can use both lower and higher RPM when called upon by the conditions but avoid running at full speed for longer periods (more than ½ hour).

A new engine will consume more oil than normal. Be especially careful with the oil level controls during the break-in period.

The freshwater / antifreeze coolant level in engines with dual cooling will rise and fall depending on the temperature. This is normal.

A good routine, especially during the break-in period but also later, is to check the engine compartment for unnatural soiling. A leak of water, oil or other can then easily be detected. An alternator belt that isn't properly tensioned or has started to line up, will always spread a layer of black dust before it finally breaks.

Engines in pleasure boats are seldom worn out - they rust away. Especially if you don't take care of the engine.

Sea water intake

HR 310, 340, 372 and HR 412 have saildrives - see the engine's manual. The sketch is for non-saildrive boats (shaft drive boats)

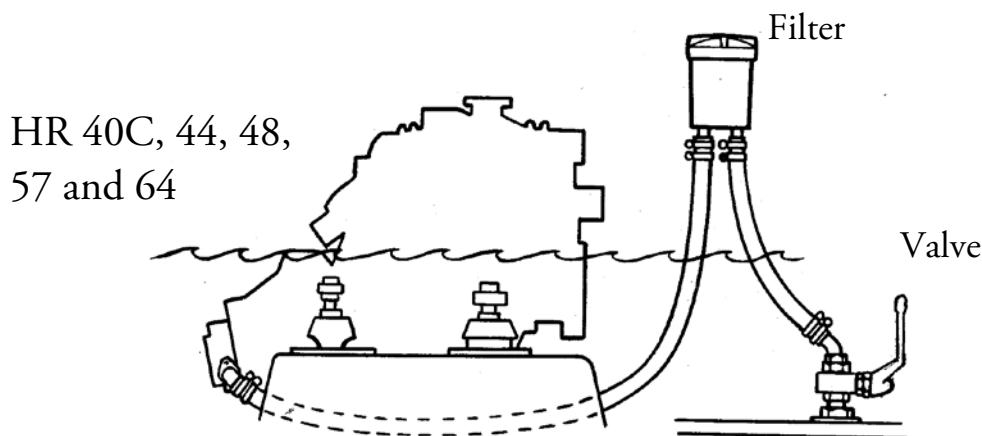

Note !

If the engine hasn't been used for a long period of time, especially after the winter, keep an eye on the cooling water pump **impeller**. Experience shows that failures most frequently happen after a longer period of non-use.

It's a good routine to "listen to the engine". Every skipper will after some time know the "sound" of the engine. You will directly hear if the exhaust is running dry, before it's too late and you will also hear how the propeller works. All this contributes to safe handling in harbours.

The propeller shaft

Normally the engine's anti-vibrators will subside a little during the first season. It is therefore important to check the level between the engine and the propeller shaft and maybe adjust it. This should be done by an expert.

The propeller shaft seals (centre cockpit boats)

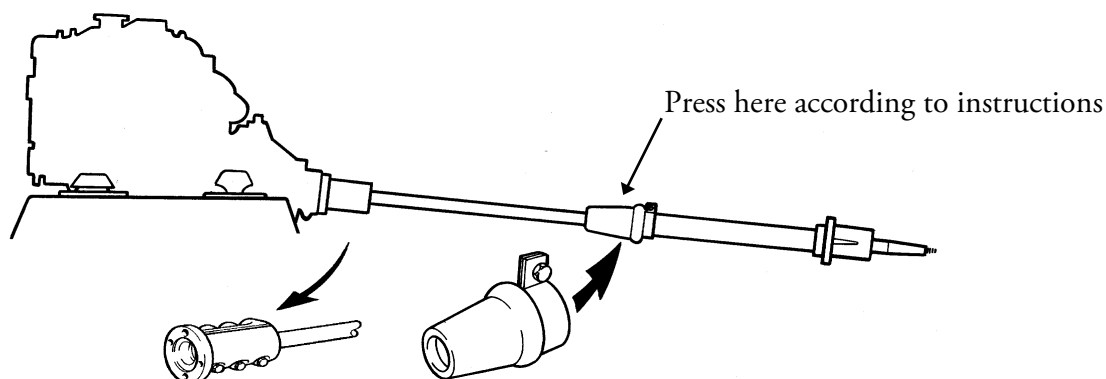

Note !

The stern gland is water lubricated and requires little maintenance. However, if the boat has been lifted out of the water the black rubber seal has to be squeezed, to be refilled with water (all boats with shaft drive). If forgotten it will run dry and quickly be damaged. All shaft drives: Grease once a year or after 200 hours, whatever happens first, according to the engine manufacturer's manual enclosed.

The outer propeller shaft bearing is maintenance free in general. However, in very bad water conditions (sandy waters) there may be a need to replace the rubber bearing. In this case you have to dismantle the propeller and two retaining screws on the sides. After this the rubber bearing can be pulled out with a suitable tool.

- 1= Engine
- 2= Gearbox
- 3= Shaft coupling clamp
- 4= Stuffing box
- 5= Shaft sleeve
- 6= Stern bearing
- 7= Propeller
- 8= Propeller shaft

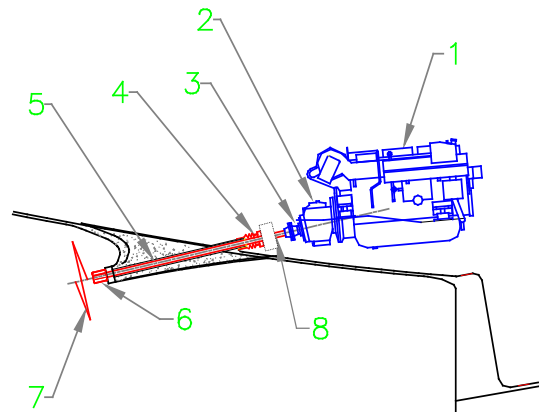

The propeller

Every propeller must be checked regularly, at least every 12 months, more frequently if the boat is extensively used. You must check the nut and that there is no play. A sail propeller with movable blades should be greased at least once every season. Check that the blades move freely. If you want to demount the propeller, please notice that this should be done when the propeller is still wet directly out of the water. If you let the propeller dry, it may be very tricky to demount it.

The **sacrificing anode** is fitted so that it is sacrificed whilst protecting the shaft and the propeller. This is more rapid when the antifouling is new, due to copper in the paint but will slow after some time. If the anode is eaten away to more than 50 % or covered by a hard shell it should be replaced. The zinc anode should be checked several times each year.

In certain waters or due to earth leakage of the shore connection there is sometimes a highly increased consumption of sacrificing anodes. In most cases it is very complicated to find a good explanation, but a good idea is not to have the shore connection plugged in more than necessary.

If you have a **Gori propeller**, this one has two gears. That means you have the first gear, with higher revolution. The second gear (overdrive) has lower revolution. The higher revolution will give slightly faster acceleration and more power against the wind in extreme situations, but a higher noise level. The low revolution is the normal gear to use, slightly slower acceleration but less noise and thus greater comfort. If you want to go **from low revolution (overdrive) to high revolution**: When your boat is making some knots, go to neutral and then for a short moment to reverse, without letting the boat move backwards. Now go to neutral and to forward again and you will have the high revolution. If you want to go **from high revolution to low revolution (overdrive)**: When your boat is making some knots, go to reverse and let the boat move backwards. Go forward again and you will have the low revolution (overdrive) gear. Please read Gori's manual for details. After using your boat for a while, you will by instinct hear by the sound what gear you are using. When in doubt what gear you use, give full gas when the engine is warm. By watching the RPM on the engine panel you will know which gear you are using.

Warning !

Important: If you have a Gori two geared propeller, the engine needs to be used at maximum RPMs on the higher revolution gear (the non-overdrive) shortly now and then, at least once a month. Also, you must not overload the engine in overdrive mode, by using higher RPM in Overdrive than stated on the next page. If you don't follow those two things, your engine will be overloaded and damaged. That will for example result in that the engine creates black smoke and/or the turbo charger stop working. The engine warranty is not valid if the above is not followed.

Maximum RPM in overdrive:

Hallberg-Rassy 64 with D6-300	1 800 RPM
Hallberg-Rassy 57 with D4-180	1 800 RPM
Hallberg-Rassy 48 with D3-110	1 900 RPM
Hallberg-Rassy 44 with D2-75	2 000 RPM
Hallberg-Rassy 412 with D2-75	2 000 RPM
Hallberg-Rassy 40C with D2-60	1 600 RPM
Hallberg-Rassy 372 with D2-60	1 600 RPM

Other models not mentioned here: maximum 80% of possible RPM with Overdrive

How to fold a sailing propeller into sailing position

First thing is to make sure whether you have a mechanical or hydraulic transmission. HR 310, 340, 372 40C and 412 have mechanical transmission. HR 44, 48, 57 and 64 have hydraulic transmission.

If you have **mechanic transmission**:

When sailing: Stop the engine. It doesn't matter in what position the throttle lever is. When the engine is stopped, take the throttle to reverse position. Now the propeller is in sailing position. Take the throttle back to neutral, so that the engine can be started up quickly, in case you should need to do so.

The procedure for a **hydraulic transmission** is completely different:

While the engine is still running, put the gas lever in reverse, but only just so much that you hear that the reverse starts to work, not more. Switch the engine off without moving the gas throttle. You will hear how the propeller folds together and the shaft is no longer moving. Then put the throttle back in neutral, so the engine may be started up quickly if you should need to do so.

The above procedures are for all sailing propellers, no matter the make.

To try to install a shaft brake is definitely something that we do not recommend and is also unnecessary.

Filling of water- and Diesel tanks

The **tank gauge** on the instrument panel shows the approximate level in the tank. All tank sensors, especially in water tanks, can however be affected by errors and the fact that the tanks are not cubic shaped and the readings should only be taken as a rough measure.

The tanks are provided with plugs for **manual sounding**. The sounding is done with a dipstick.



Environment protection

Water tanks can be filled until they overflow on deck. This **must not** happen with diesel. **Oil spill is forbidden!! Do not overfill!**

Wet the teak deck with water before opening the deck fill to avoid discolouring by the almost unavoidable diesel drops. Do not smoke while refuelling the boat. Do not damage fuel lines. Avoid contact of flammable materials with hot engine parts.

If you want to fill up to full capacity of the tank, do not rely on the tank meter! Use the plug and a dip stick.

Do NOT overdo the tightening of the cap. A little water respectively diesel oil on the gasket in the cap will prevent damage.

Never risk running the tank empty. First of all a dangerous situation may develop.

Second it can be complicated to vent the fuel system to get the air out of the injection pumps and nozzles. In spite of self priming qualities this is a problem that should be avoided at all times.

If it should happen: consult the engine manual.

The water and diesel tanks Hallberg-Rassy 40C - 44

If double tanks are fitted the tank gauge will always show the level in the lower tank. From the higher tank a pipe with a shut off valve leads to the lower. This valve should only be opened to drop the content of the upper tank down into the lower tank. After this the valve should be closed again.

The safety fuel intercept in case of fire is done manually on the tank

A few words about diesel oil

The diesel oil can be blue, grey, neutral, yellow or any colour. All this is of no consequence. What's important is that it's clear and free from water.

It's simple to take a sample of the oil in your main diesel tank. In the engine compartment you will find a hand pump in brass fitted on a bulkhead. (centre cockpit boats). Directly below the pump is a valve. Open this valve. The outlet hose is put into a glass jar. The pump draws oil from the lowest point in the tank and you can easily check the quality of your fuel. If necessary you can pump off any sludge or water with the same pump. Close the valve after use, as diesel may overflow when the tanks are filled.

Diesel consumption and range

The fuel consumption is directly depending on speed, the sea state and hard winds. How clean the under-water body and the propeller is, is also very essential. It will differ widely, up to six times from economic to full speed. Never under-estimate the period of time the engine might be in use, always count with a safe margin. Remember that the tanks should never be run empty!

Rough estimation for diesel consumption per hour at 70-75 % load in calm waters and clean under-water body and propeller (no responsibility taken):

Hallberg-Rassy 310	1.9 litres
Hallberg-Rassy 340	2.2 litres
Hallberg-Rassy 372	3.1 litres
Hallberg-Rassy 40C	3.9 litres
Hallberg-Rassy 412	4.4 litres
Hallberg-Rassy 44	4.5 litres
Hallberg-Rassy 48	6.5 litres
Hallberg-Rassy 57	9 litres
Hallberg-Rassy 64	10 litres

The fuel consumption is depending on what kind of propeller you have chosen. More detailed figures may be found on www.hallberg-rassy.com and look for your yacht model and fuel consumption / propeller data.

Note !

These figures are regarded to cruising speed (=appx. 70-75 % of maximum RPM) in smooth sea conditions and little wind with an empty boat. The figures are also with a very clean under water body and very clean propeller. What this cleanness does for the fuel consumption, can only be under-estimated.

Drawing of Diesel system Hallberg-Rassy 310, 340, 40C, 44

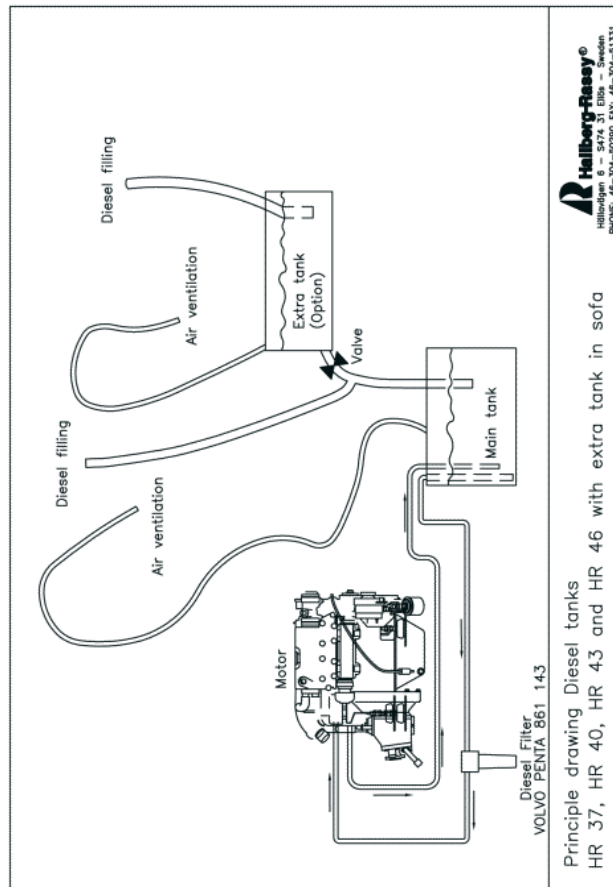
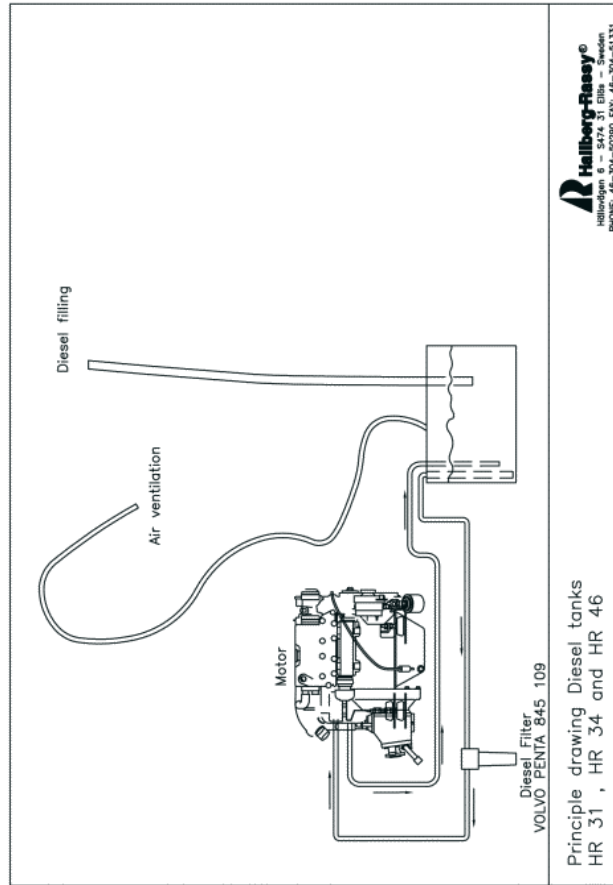

Drawing of Diesel system Hallberg-Rassy 412

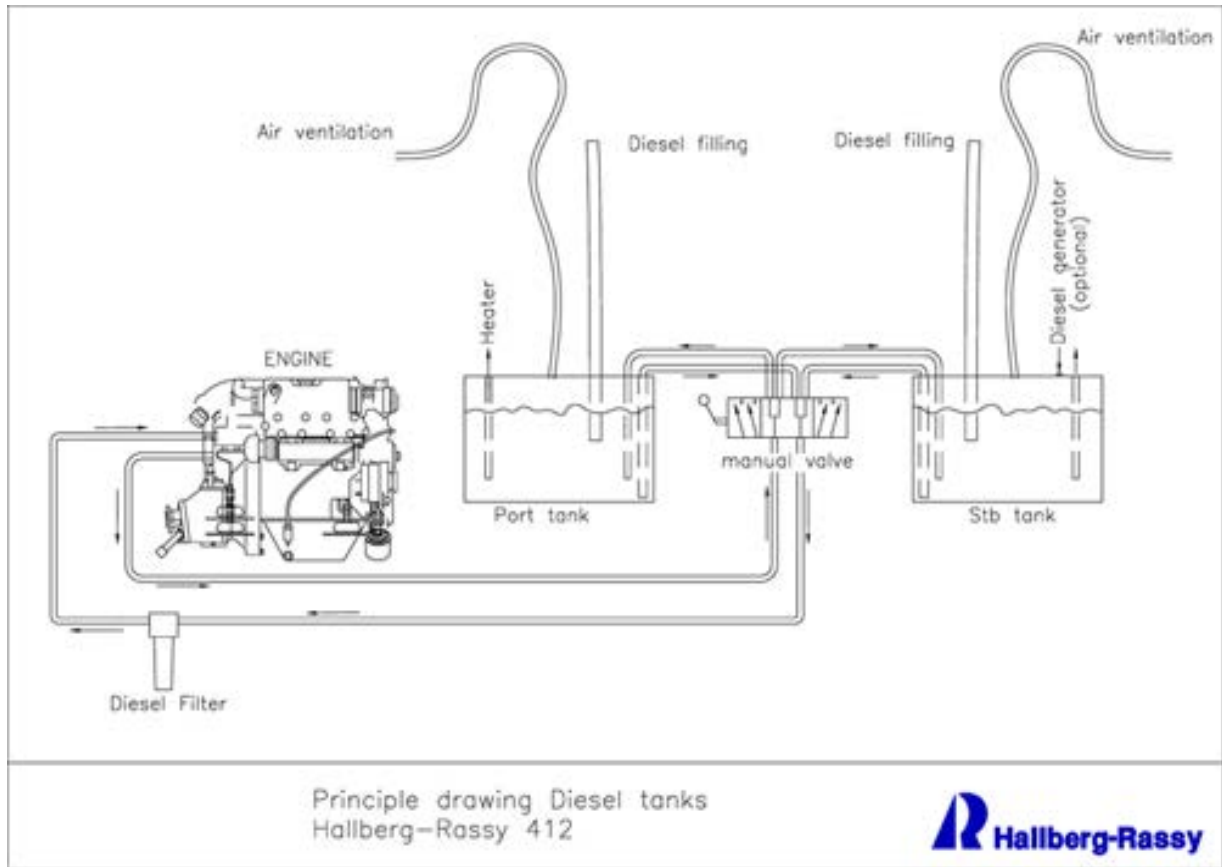

Drawing of Diesel system Hallberg-Rassy 57

Principle drawing
Diesel system HR 57

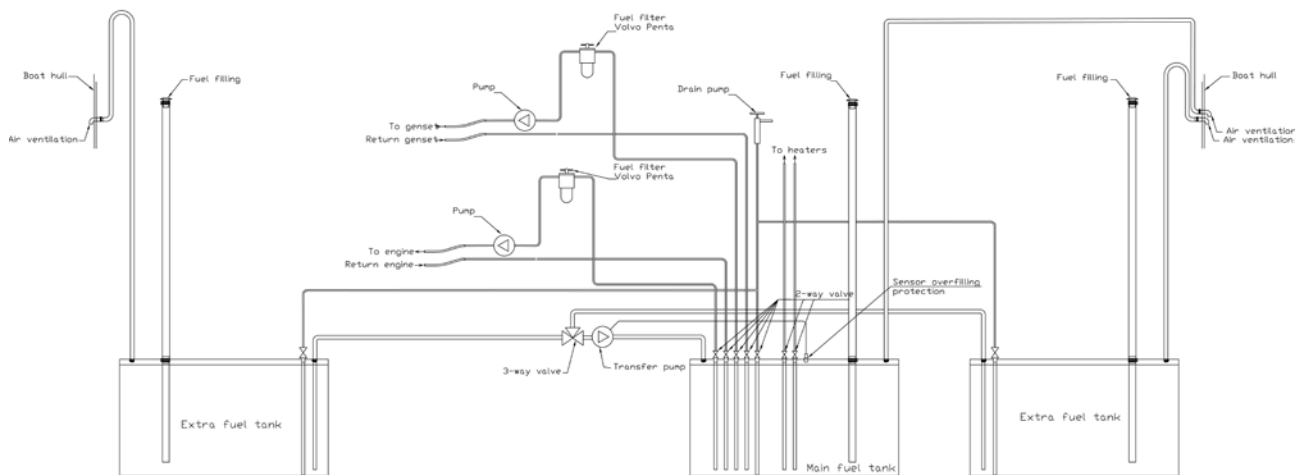

Drawing of Diesel system Hallberg-Rassy 48 and 64

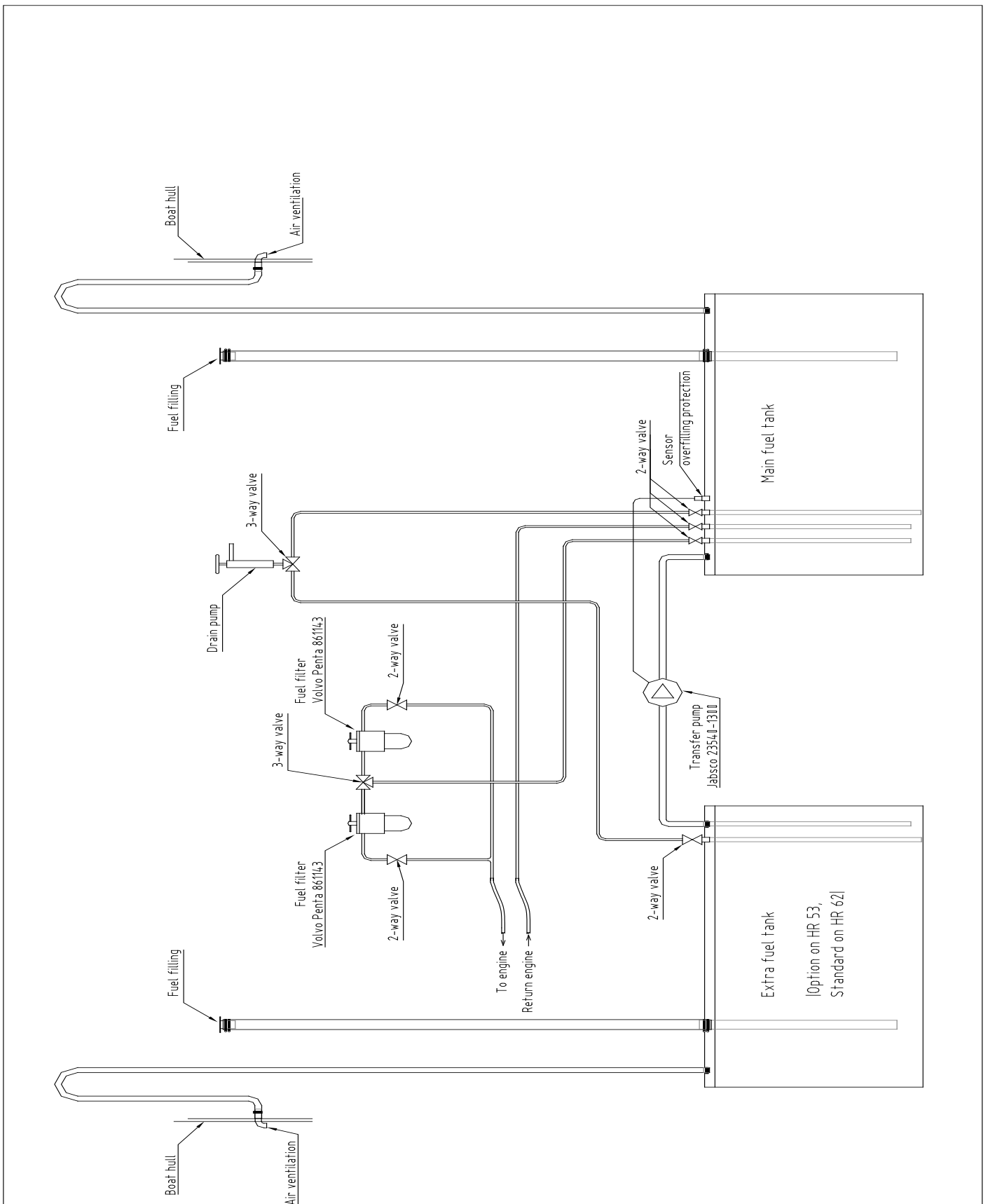

The mast and the rig

A detailed manual from the mast manufacturers Seldén Mast is attached.

Warning

When sailing downwind with a risk for unintentional gibing, you shall use a preventer line. Please notice that this line must be lead from the aft end of the boom (labelled “preventer only”) to one of the forward mooring cleats. If you should place the line further forward on the boom, you may break the boom.

Every mast must be checked and re-tuned regularly, at least after one month. Especially a new rig needs after tension. Failure to do so may result in rig failure.

The back stay tensioner

You may use normal force to tension your back stay. The mast will then take a bend aft-wards and this is as it should be. In harbour the extra tension should be released.

Furling mainsail, shackle on boom

Please be aware to install the shackle between the outhaul line on top of the boom with the screw, up, not down. If the screw is positioned down, it will cause ugly scratches on the upper side of the boom.



Incorrect position – will scratch the boom

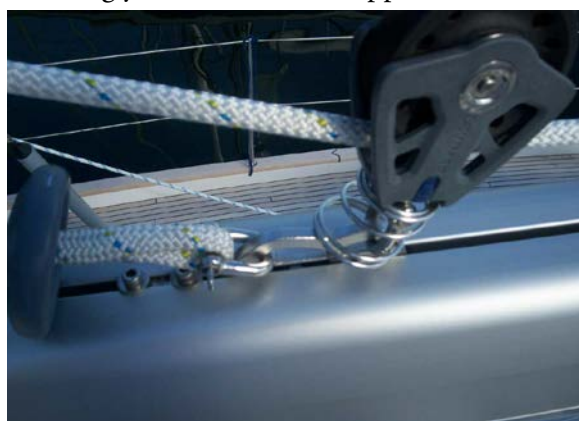

Correct position – shackle will not scratch the boom

Furling mainsail outhaul to cockpit

In case you have a furling mainsail with outhaul line lead back to the cockpit, please be aware that this line has a lot of load and shall not be adjusted under pressure. Either ease the mainsheet or go up to the wind direction to take the pressure out of the mainsail when adjusting the outhaul line.

Swan neck fitting for cables

Centre cockpit bots have one or more stainless swan neck fittings for cables. It is a good idea to slice a soft sponge into pieces and put these parts in the swan neck, to prevent water and air to be forced in under extreme conditions.

The cutter stay

For extended crossing over open water and/or cruising in over 0.5 m waves, you shall use the cutter stay and runners on the HR 64 to prevent pumping. We would like to point out that this is valid no matter if you sail or use the engine only. You attach the stay already in the harbour at the chain plate on the fore deck. When using the cutter stay, you shall use runners (checkstay) on the windward side.

The best procedure is as follows:

Attach and tension the cutter stay until there is a slight bend forward on the mast. Move the runner from the mast to the back end of the toe rail. On HR 40C-48 this is hooked on the backstay chain plate on the cap rail near the aft pulpit. On boats over 50 ft this fitting is not strong enough for the runners. Those boats have permanent blocks for runners on the deck just in front of the aft cleats. Tighten the runners with help of the genoa winch. If the main sail is so deeply reefed that it clears the check stay, you can set both runners. Move the topping lift to the mast and now you can tack without touching anything important.

We recommend that the runners free rope is secured after the clam cleat either on the mooring cleat aft or on the block. This arrangement is perfect for heavy weather. The optional stay sail is not intended for use together with the normal head sails. No special winches are provided.

On some models a cutter stay that may be parked at the mast. On the spreader and the foot of the mast you then will find a fitting of which the stay can be bent around and brought up to another fitting where it's hooked in and tightened. If properly laid the stay will cause no noise.

Cutter stay is an option on Hallberg-Rassy 40C, 44, 48 and 57 and standard on the 64.

Warning !

Opening centre part windscreen

If you have a boat with mainsheet track in front of the windscreen, you shall not sail with the centre part of the windscreen opened. If you do, the mainsheet will catch the glass and it will break.

Working Deck Area

The area of the superstructure in front of the windscreen and aft of the mast is not considered as Working Deck Area, and consequently the ant slip is not made for that in this area.

Deck lockers

The deck lockers have a locking fitting that should be used so that the arm is flushed on the upper side. In that way the lock will compress when closing. Using the wrong side up will not compress and consequently not be watertight. Please have in mind that the 57 and 64 are drained to the inside grey water tank of the boat, which is normally not an issue but is good to know in case you clean the box and flush a lot of water into it.

The sails

Sunlight affects the strength of all sail cloth. For this reason sails not in use should be protected by sail covers, if not furled. Mildew is not a problem for the strength of the sails but seams and laminated sails can be discoloured if stored or rolled wet. Remove your head sails during extended stays.

Gennakers / asymmetrical spinnakers on bowsprits are not designed to be used in more than 14 knots true windspeed.

Silicone or Teflon spray on the sail track will make hoisting and lowering easier.

Have a sail maker look over the sails at regular intervals, depending on use!

When tacking, make sure that the foresail has to be moved over the centerline by the wind, only then you should pull the new sheet. Only in that way you minimize the risk of the sheet to hook in some kind of fitting.

If you have a non-furling mainsail, put the mainsail cover in place in the following order: Start to put the forward part in place and close the zipper. Then pull as hard as you can in the aft end to get a good tension. Finally close the fittings in the lower end. Only this order gives a good looking sail cover.

Sail dimensions

	P (conventional mast)	P (Furling mast)	E	I	J
HR 310	11.10	11.10	4.00	11.90	3.52
HR 340	13.10	13.10	4.38	13.72	4.02
HR 372	14.38	14.35	4.80	15.04	4.17
HR 40 Mk II	16.30	16.30	5.33	17.17	4.60
HR 412	15.93	15.93	5.33	16.82	4.60
HR 44	17.64	17.64	5.70	18.36	5.00
HR 48 Mk II	18.27	18.02	6.34	19.70	5.55
HR 57	-	22.40	7.20	23.26	6.65
HR 64	-	22.75	7.80	24.80	7.38

Always check your sail measures on board!

The batteries and charging

Your batteries are an important part of your yacht and they need attention.

Never forget that all capacity you take out you have to recharge and this takes a considerable amount of time. The number of batteries and equipment for charging is different for each type of boat and from boat to boat depending on optional equipment fitted.

Irrespective of this a regulator is always fitted that allows a stronger charge when the batteries are low and that brings the charging current down when the batteries are more charged. This means that you don't have to constantly monitor the charging.

Don't underestimate the time required to charge the batteries. Only if the engine is running for a very long time (15 hours or more) or charged by an appropriate **battery** charger over night, you can calculate with fully charged batteries. You can manage with just charging 2-4 hours per day for some time, but in the long run longer charging is needed. Sooner or later you will get a calm day with many engine hours or a chance to plug in your charger to shore connection.

The alternator on the main engine will give **full charge at 1 300 rpm**. If you want to charge with the main engine in neutral, push the button on the engine control lever and adjust the engine rpm without turning the propeller.

Charging the batteries to 100% with the engine's alternator is practically impossible, it would take too many hours of running the engine, except if you have optional LiIon batteries. Unless you have LiIon batteries, one needs to accept that you can only achieve approx. 80% without access to shore power. When using shore connection, be sure to charge the batteries 100%. This should be done at least once a month.

A 230 v AC diesel generator (optional) is normally charging the batteries through a battery charger.

It's important not to leave the batteries with a low charge as an ageing process will start. This will be prevented by recharging. This is of course specially important when you leave the boat for some time.

We strongly recommend you not to leave a charger unattended for several days.

The reason is as follows:

Most battery chargers are said to be able to regulate and in time stop the charging, but this is not the case under all conditions and overcharging will result. **DO NOT** leave the charger on when you leave the boat for a longer time. When you are on board it is all right to leave it on as the voltage can be checked now and then. The voltage should simply not be allowed to exceed 14.2 v with a 12 v system and 28.4 V by a 24 V system in normal climate. (In tropical waters it will be 13.9V / 27.8V)

Note !

The voltage should not be allowed to sink below 11.5 V (12 V system) respectively 23 V (24 V system).

If this happens; charge the batteries as soon as possible.

Often you find more than one voltmeter. One is on the main switchboard. Another belongs to the charger. A third may occur on a special battery controller. They can show slightly different values. The most exact is the one the battery controller, next the charger and last the meter on the panel.

For wet batteries, check the acid level in the battery, it should be around 1 cm more than the lead plates and **fill if required** with distilled water at least once a month. At heavy use and/or in tropical conditions this may have to be done more often. If you have a BSF manual pump system for filling water to the batteries, you shall pump until there is resistance in the system.

Danger!

Batteries may explode. Always approach the batteries with utmost care.

Self discharge

You should consider the self discharge if you leave the boat **unattended for a long time**.

Below 8° C the self discharge is nothing to speak of. The batteries will keep their charge for at least six months. At 15° to 20° C, such as autumn in the Mediterranean, it will give no problem. At temperatures over 20° C the self discharge has to be noted and over 30° C it must be supervised.

One month without charging should not be a problem, but three months can give you trouble.

Only when the cables are removed from the battery terminals you can be sure that all equipment is disconnected, which is essential.

New and well maintained batteries will naturally stand better than old.

The best way to check the charging of the batteries is by measuring the specific gravity of the battery acid. This is, however, best made by professionals. Battery acid is highly caustic.

If the voltage, after charging a few minutes, doesn't come up to 12.5 respectively 25 v or for an extended period exceeds 14.2 respectively 28.4 v something is wrong and the charging must be stopped until investigated.

A few words about consumption of electricity

We repeatedly get the question: How much power does the autopilot, the fridge or the heater use?

These questions cannot be answered as the consumption of an electric motor depends on how much it's loaded and for how long it runs.

When operating an electric windlass the main engine **must** be running.

The drain from the autopilot much depends on the sea condition and how you carry your sails. The drain is however often overestimated.

A heater that is running day and night is naturally using more electricity than one that is shut down in the evening and restarted in the morning.

A refrigerator is on the contrary best left on day and night. The thermostat setting, however, has a direct influence on the power consumption.

A modern well equipped yacht offers every modern convenience and it should also be expected to cope with the extended power consumption. However, on any boat the following cannot be disregarded. **Charge the batteries regularly** and keep an eye on the power consumption. Then you will have no problems.

The worst thing that can happen is that a battery or one battery cell is damaged without being noticed. This will inevitably lead to damage to all batteries that are connected to the faulty one. Symptoms you should beware of; Rapid loss of power by discharge and difficulties to reach full charge are as well as an acid smell. Have the battery checked by a professional.

The second worst thing is a small lamp left on that will gradually drain your batteries to the last drop. To avoid this: **Always turn off the main switches** before you leave the boat for some time. Or if it's for a **longer time: disconnect the cables** directly on the batteries.

Larger boats are often fitted with a **battery controller**. On this instrument you can see how much electricity is going out or in and also see how much each consumers differ. It also shows how many ampere hours that have been used or charged into the batteries. This is the best way to get familiar with your electric balance.

Warning !

If you have a Mastevolt Combi or an inverter and forget it in ON position it can drain the batteries quickly as the idling consumption is quite high. If you also have a TV, digital TV tuner or similar that is standing in sleep mode, the current draw is even higher. You have to switch the main switch for the combi off when leaving the boat for more than a week of non-use.

Do not obstruct battery ventilation ducts.

Safety with 230 V on board

Danger !

The optional 230 V system is fitted with an earth leak switch (residual current circuit breaker) and a number of combined switches and overload circuit breakers for the different outlets. The GFCI switch is a safety device preventing accidents with electric shock if an electric lead should be touched. If it is triggered off all outlets will be dead. Try to re-engage by lifting the toggle switch after first breaking each of the circuit breakers.

To minimise the risk of shock or fire:

- Connect the shore connection cable **first on board** before it's connected to the shore outlet.
- Disconnect the shore cable **first at the shore outlet** before disconnecting on board. Close the cap carefully.
- Do not change the plug on the shore connection cable, use proper adapters to fit different shore outlets.

Remember:

If there is no earth breaker ashore, you are not protected against electrical chock on the way from the boat to shore.

Note !

The GFCI switch is so sensitive that rain or a damp connection can trigger it.

Warning!

Do not work on energized AC system

Danger !

There is a risk of swimming close to a craft connected to shore power.

Danger !

There is fire or explosion hazards that may result from improper use of electric DC and AC systems.

Recommendations for use of generator and main engine

Seawater may enter an engine if something is wrong with the anti-siphon breaker or the boat has been heeling at a greater heeling angle than the exhaust system is designed for. There are two different versions of the anti-siphon breaker: The first one is where water spills through a spill hose connected to a drainage, the other one is a vacuum valve with a check valve.

The anti-siphon function must be checked several times a year. A failing anti-siphon valve may damage the engine completely, so make sure the anti-siphon break works as it should. The version with spill hose: Make sure the water stops flowing in the spill hose when the engine is stopped, so that the air is coming in instead and the siphon breaks. The version with check valve: Unscrew the nut, verify that the check valve is working and not packed.

The main engine is installed in the centre of the boat and is less sensitive in this respect compared with the **diesel generator** that almost always has to be installed off-center in the engine room.

We would like to make the following recommendations:

- Avoid using generator and engine if the boat is heeling more than 15 degrees. Heeling to the side where the generator is installed is more critical. The generator is installed on the starboard side of the boat on a HR 44, 48 and 64.
- Never turn off the generator on a 44, 48 or 64 when the boat is heeling over to starboard
- Start the generator and engine every 24 hours when sailing offshore - this routine normally prevents permanent damages if seawater has entered the cylinder head.
- Always start generator and engine immediately after excessive heeling caused by a freak wave, knockdown, etc.

The water system and the water heater

The water is drawn from the tank by an electric pump to the taps under pressure. Between the pump and the taps there is a pulsation damper and sometimes a water heater and a filter. The equaliser is filled with air and should not be opened or vented. See sketch.

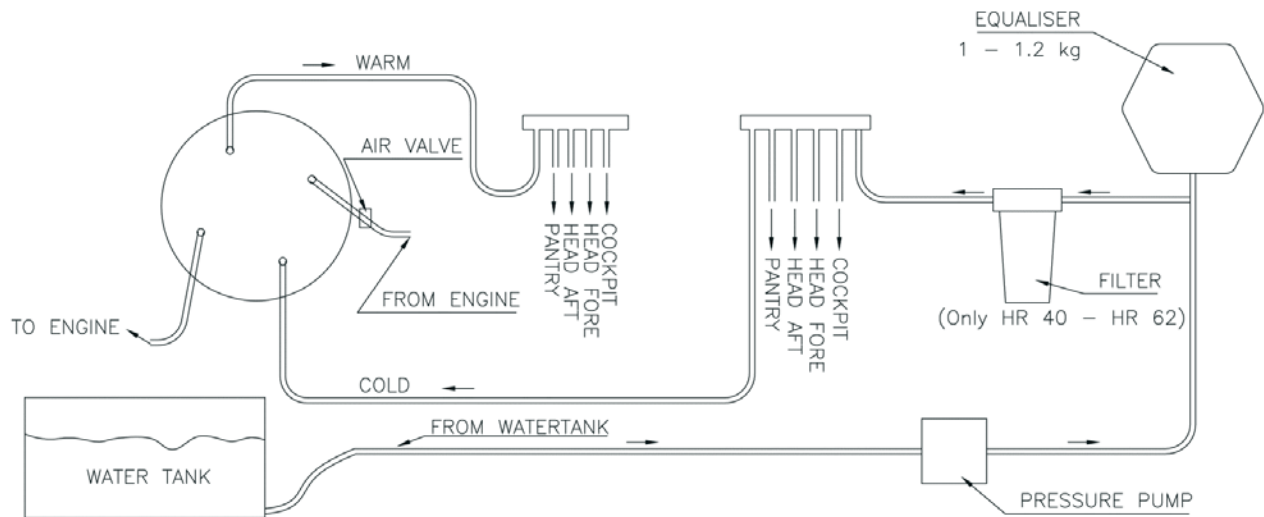

The insulated **water heater** needs no regular attention. It's fitted with a safety valve which will let water come out if it gets overheated. If you notice that the water gets warmer when heated by the engine than by electricity this is normal. The thermostat is set at a lower temperature to avoid rapid lime stone to build up. As the shore electricity in some marinas have imperfect earth, which may cause heavy corrosion on the inside of the heater. The only way to avoid this is to disconnect the shore power or to have an insulation transformer fitted on the power intake,

In some places the pipe water contains amounts of salt which make it very corrosive when heated. Mallorca is well-known for this phenomenon.

As the **water filter** house is transparent you can easily see when the cartridge needs to be replaced. (HR 40 – HR 64).

To do this: switch off the fresh water pump at the panel and open one of the taps to release the pressure. After this you can unscrew the lower part by hand. The cartridge can be washed, or better replaced. If a replacement cartridge, which is normally available at well stocked dealers, should not be available, it can be left out.

After refitting the filter housing, the air should be let out through a tap or at the vent on the top of the filter

The HR 64, has two water tanks, one on port and one on SB with no connection between them. Both tanks has a separate pump, filter and equaliser, but share the same water heater. You can choose which tank to use on the switchboard.

The equalizer shall have 1-1.2 bar. It is only possible to check the pressure in a pressure less system. That means no water in the hoses. Shut off the pressure water pump and open the tap. Check the pressure. Fill up pressure until you have 1 bar. This must be repeated until the water in the hoses is gone.

Fresh water system Hallberg-Rassy 372 and 412

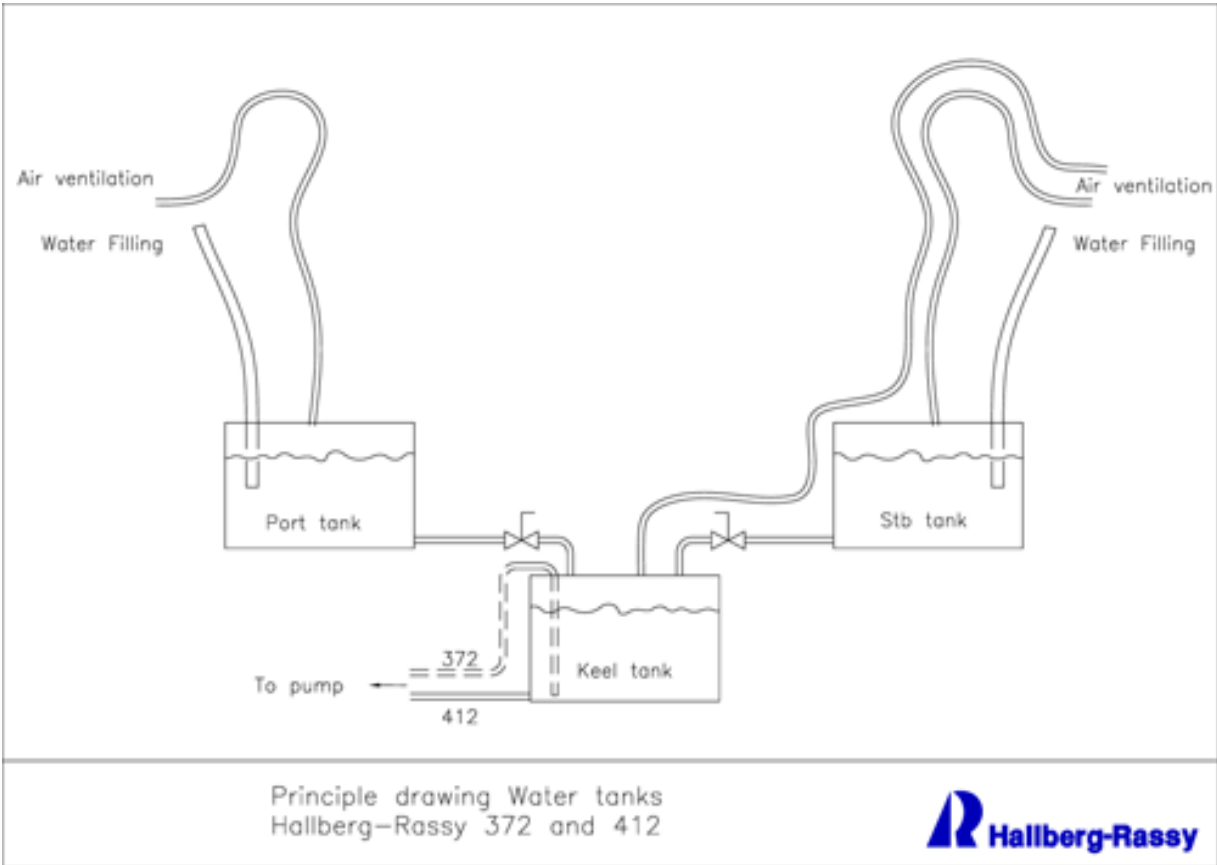

The refrigerator

The ice box has no drain, as it is only in this way that it is possible to keep the bilge clean. Make it a routine to clean the box at least once a week.

The ideal temperature for keeping meat and some other food fresh is just over freezing point. Where two boxes are fitted, one is normally used as a freezer.

For longer crossings it may be an advantage to use one of the boxes for vegetables and canned drinks etc., at a slightly higher temperature than in a normal refrigerator. In this way vegetables may keep for up to three weeks.

For frozen food a temperature of minus 5-6° C will be sufficient in most cases to keep them in perfect condition for several weeks. The deep freeze temperature (- 17°) used at home is only needed for long time for the keeping of fat food.

Use a separate thermometer in the box as the marking of the thermostat knob has no relation to the temperature to be set in degrees.

Note !

Temperature has a big influence on the battery drain and the power consumption is something that must always be kept in mind on a boat.

The heater

Today's heaters have reached a high level of dependability but three things can cause some concern:

- Discharged batteries
- Clogged burner as a result of shutting off the heater with the fuse or at the batteries not allowing it to run out as programmed.
- Old diesel oil when the heater has not been run for several months.

For this reason pay attention to the chapter on battery charging and always stop the heater with its control panel.

The heater is connected with direct power supply. That means that if turning the main switch off, you also have to turn off the heater at the heater panel.

The heater has an overheating protection that may fall out. If that happens: Consult the heaters manual.

Run the heater once every month, but note that the thermostat setting may prevent the unit from starting at high temperatures.

The toilet

Don't pump dry.

Keep the valves for the outlet and the tank closed and the small lever to the right on the toilet on DRY when the toilet isn't in actual use. If you forget that, flush water may penetrate the bowl and seals are exposed for overpressure, resulting in blackwater re-entering the bowl.

Don't use cleaners that can be aggressive to the rubber in the toilet valves. Household detergents for domestic toilets are for this reason usually not suitable in the toilets.

Some models have electric toilets. A push button is located near the toilet which will activate the electric pump.

Warning

Always close the valves after use. This is the only way to guarantee the toilet to be water tight. Inform all users of the safety operation.

The holding tank

Close to the toilet bowl there are two handles operating the valves. If you want to pump into the tank: open the upper valve, keep the lower closed. Have both closed when you are finished. If you want to empty the tank to the sea: Open both handles. Do not discharge holding tanks close to shore or in prohibited zone. Use harbour or marina pump-out facilities to empty the holding tank before leaving the harbour. Notice local environment laws and codes of good practise. If you are in an area where it is prohibited to discharge holding tank into the sea, it is possible to seal the handles for out to sea.

If you want to empty the bowl to sea without emptying the tank: Open the lower valve but keep the upper one closed. Empty the tank as soon as possible, but no later than three days after use. Be aware of international regulations against marine pollution (Marpol) and respect it as much as possible.

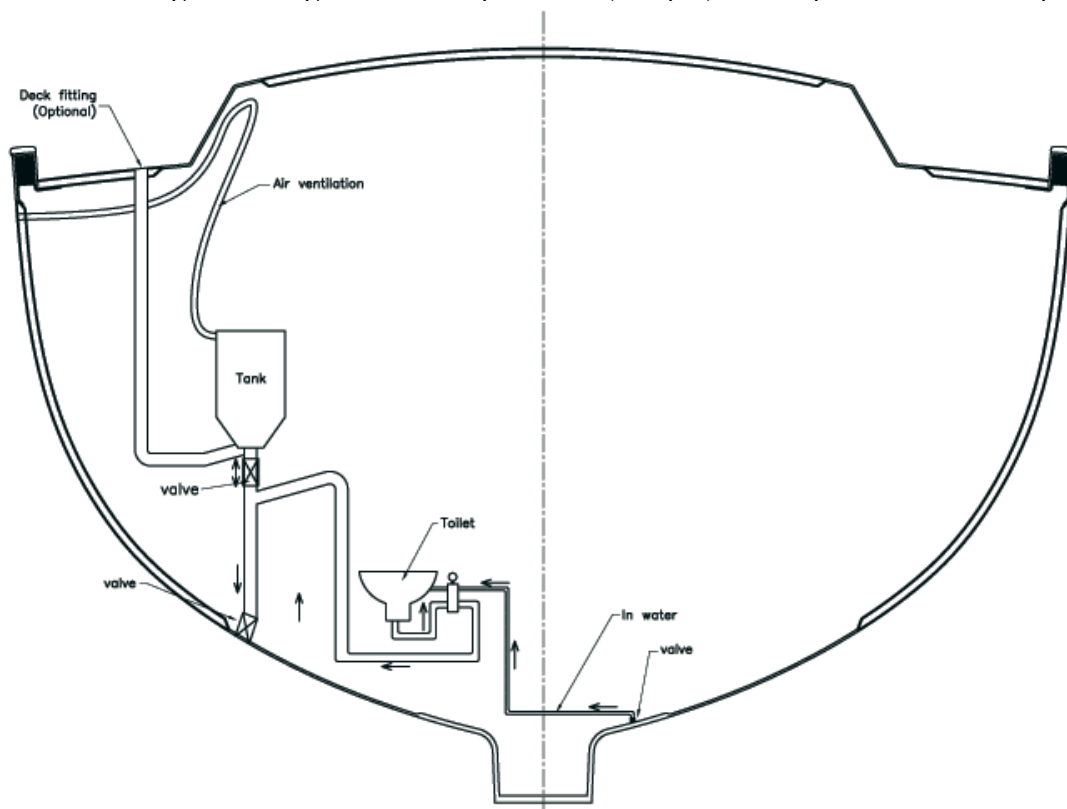

Holding tank system Hallberg-Rassy 64

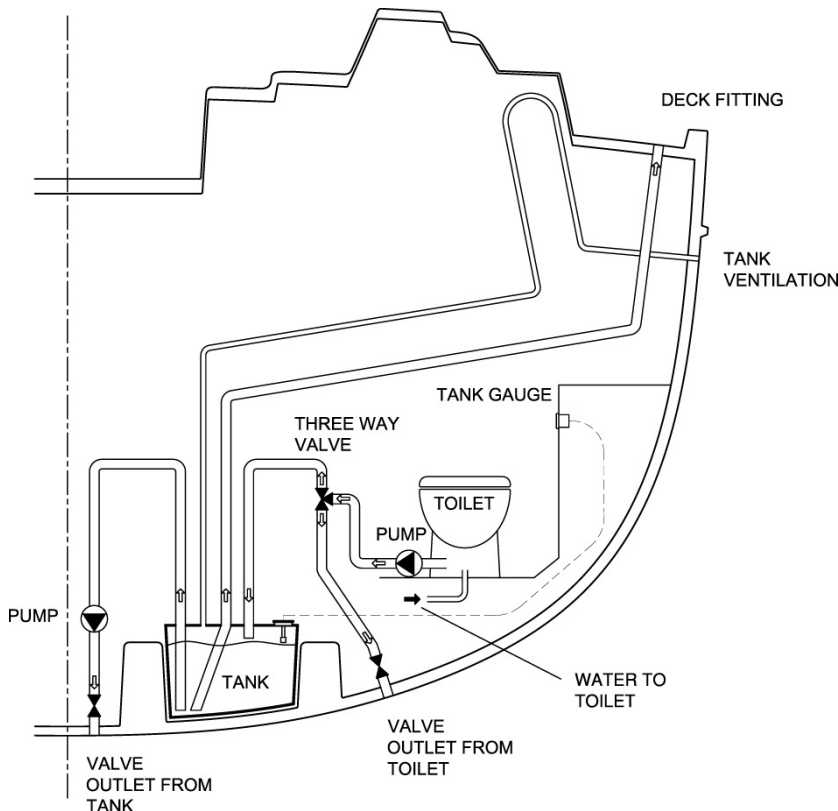

The manual bilge pump

The manual bilge pump is of a membrane type, which means that no strainer is needed in the bilge. One condition is, however, that the bilge has to be kept relatively clean. Paper labels and larger objects must be avoided. During the first time some saw dust and small wood debris will, in spite of scrupulous pre-delivery cleaning, find their way from hidden pockets to the bilge. The pump can be opened for cleaning, if needed. Check function of bilge pumps at regular intervals

WARNING! The bilge pumps are not designed for damage control.

The electric bilge pump and the drain pump

An automatic electric bilge pump is convenient but very unreliable. There's a strainer in the bilge that can be clogged. From safety- view don't rely on the electric bilge pump.

Regular flushing the bilge with water and detergent and pumping out with the manual pump will help delaying the clogging of the strainer for the electric bilge pump. If you leave the boat for a long time it should be shut off. The pump can be opened for cleaning, if needed. Check function of bilge pumps at regular intervals

WARNING! The bilge pumps are not designed for damage control.

Be aware that there will always be some water in the bilge. The hot water calorifier has a certain volume when it is cold, and when heated up, the volume increases and the difference flows out and further into the bilge. Bilge water should be kept to a minimum.

Bilgepumps

Position and capacities				
Boattype	Type of pump	Capacity acc. to pump manufacturer	Position	Option
HR 310	manual bilgepump	105	in cockpit	
	emergency bilgepump	252	in bilge, controlled from cockpit	
	electric bilgepump	16,3	in engineroom, controlled from vanity port aft in saloon	x
HR 340	manual bilgepump	105	in cockpit	
	emergency bilgepump	252	in bilge, controlled from cockpit	
	electric bilgepump	16,3	in engineroom, controlled from switch panel in saloon	x
HR 372	manual bilgepump	90	in cockpit	
	emergency bilgepump	252	in bilge, controlled from cockpit	
	electric bilgepump	16,3	in engineroom, controlled from chart table	x
HR 412	manual bilgepump	105	under cabinsole above bilge	
	emergency bilgepump	252	in bilge, controlled from cockpit	
	electric bilgepump	16,3	under cabinsole above bilge, controlled from chart table	
HR 40C	manual bilgepump	105	In floor beside inner chart table	
	emergency bilgepump	252	in bilge, controlled from cockpit	
	electric bilgepump	16,3	in engineroom, controlled from chart table	
HR 44	manual bilgepump	105	in walk through to aft cabin	
	emergency bilgepump	252	in bilge, controlled from cockpit	
	electric bilgepump	16,3	in engineroom, controlled from chart table	
HR 48	manual bilgepump	135	under cabinsole above bilge	
	emergency bilgepump	233	in bilge, controlled from cockpit	
	electric bilgepump	14	in engineroom, controlled from chart table	
HR 57	manual bilgepump	135	under cabinsole above bilge on port side	
	emergency bilgepump	233	in bilge, controlled from cockpit	
	electric bilgepump	30	in engineroom, controlled from chart table	
HR 64	manual bilgepump	135	under cabinsole above bilge	
	emergency bilgepump	233	in bilge, controlled from cockpit	
	electric bilgepump	30	in engineroom, controlled from chart table	

The anchor windlass and chain

Two things are important:

- Always run the engine if an electric windlass is used. (To charge the batteries)
- Lubricate regularly.

Tighten the clutch only so much that the anchor will come over the roller, but no more.

Danger

ALWAYS KEEP CLEAR OF THE CHAIN.

The windlass is unbelievably strong. If you have the ability to operate the windlass from the cockpit, be sure nobody is in the way on deck.

When the anchor is up, it shall be secured with a line. You shall also turn the switch for windlass off. Otherwise you may accidentally launch the anchor when sailing.

You should be alone near the windlass when you work with it. Keep away from the chain and be careful. Keep children away!

Handling:

On the top or on the starboard side, depending on type of anchor windlass, is a clutch that is operated with a separate handle. By releasing the clutch the chain- gipsy can be made free from the rope drum, making this available for hauling of lines.

To drop the anchor, first ease the clutch by turning the handle anti clockwise, sufficient to lift the anchor forward, until it hangs vertical from the bow roller, ready to drop.

If your anchor windlass has a two-way electronic control, the clutch needs no attending and the chain can be backed up by pushing the "down" button.

If the clutch is used to drop the anchor, also use this as a brake to regulate the speed.

If the anchor winch's electric motor is overloaded, the automatic circuit breaker will trigger off. The combined switch and overload breaker is found near the navigation table or under the forward berths.

When at anchor, the steamhead fitting and the anchor winch shall not be under load. Neither the steamhead fitting, nor the anchor winch is designed to take the forces that may occur when anchoring in fresh wind. To unload, you shall hook a mooring line in the chain. The other end is tied at the cleat. Then you release so much chain that the load comes on the mooring line and not on the chain. As a bonus, that will also reduce the noise in the boat under anchor.

Anchor Chain

Galvanized Chain is standard on all boats that are delivered with a windlass.

You can expect to have to re-galvanize the chain after app. 3-5 years if you are on an extended cruise with daily use of the anchor.

A way to extend the life of the chain is to take the chain out and put the anchor in the other end after 3 years.

Stainless Steel Chain has many advantages

- It stores better in the anchor locker, which means you can carry more chain
- It does not bring up as much dirt on deck
- It has a higher breaking load than the standard galvanized chain
- It never needs to be re-galvanized

Not even the best stainless steel is 100% corrosion free. Under extreme conditions your Duplex chain can also corrode if not treated well. The most critical factor is the temperature together with saltwater. The Duplex 316AISI316LN chain is OK up to 34.5 degrees Celsius. Water temperature more than 34.5 degrees is hard to find. But do not forget that the temperature in anchor locker might be exceeding those temperatures in hot climates. A short flush with fresh water will however take care of that problem.

Maintenance Chain:

Check the “Bitter end” rope regularly. The bitter end of the chain is connected to the bottom of the chain locker and can easily be cut in case of an emergency. Turn the chain around after some years. (Put the anchor in the other end) Regularly check the chain for cracks. Replace the shackle between chain and anchor regularly. Flush the chain regularly with fresh water. This is important both for galvanized and stainless steel chain if you leave the boat in hot climates for extended periods.

Bow thruster

Your yacht may be fitted with an optional bow thruster, to help manoeuvring in harbours. It is operated by foot buttons. Starboard button pushes the boat to starboard and vice versa. Avoid getting lines or floating plastic drawn into the thruster tunnel. The manufacturers manual should be referred to regarding maintenance and limits for maximum operating time.

If the boat is equipped with bow and / or stern thruster, the bow / stern thruster batteries will be charged from service bank. Therefore , note that if you have been running the thruster a lot, one must allow these circuits to be charged by the main circuit in about 4 hours, until power of the main circuit may be broken.

Dishwasher, washing machine and micro

If your boat is equipped with an optional dishwasher, washing machine or micro, please be aware that those are only designed to be used in upright position. Do not use it when heeling. If you do so, those will not work properly.

The liquefied petroleum gas system

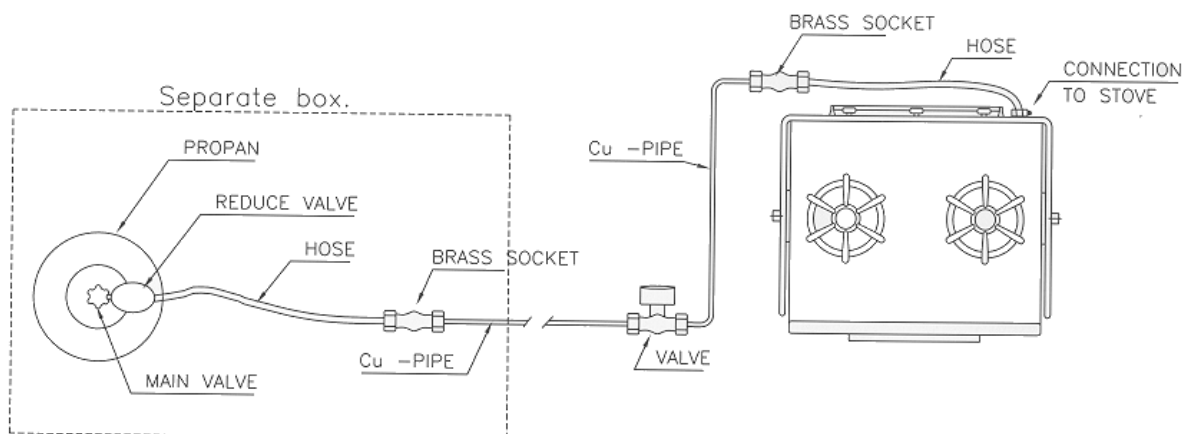

Danger

Read the following advice thoroughly and handle your stove with care, especially regarding liquefied petroleum gas.

The stove is equipped with an automatic closing mechanism. This means that the gas supply is shut off automatically after approx. 30 seconds, should the flame go out. To light a burner the control knob must be pressed and turned clockwise, minimum a quarter of a turn. Keep pressing the knob for 10 seconds after the flame has been lighted.

The stove flames consume oxygen and produce combustion gases. Therefore ventilation is required. If not, the risk of suffocating can arise. Besides water vapour is generated at the combustion of gas. Make sure the access to the valve is not blocked so that it can be reached easily by everyone. Always keep the bottles in the special vented compartment. Storing below deck would be fully irresponsible, as eventual leaking gas is heavier than air and will collect into the bilge and a direct danger of explosion will develop.

The burners and the pressure regulator are made for a certain pressure which is labelled on the stove and on the reduction valve. The pressure of the reduction valve must correspond with the one on the stove.

Close fuel supply line valves and cylinder valve when appliances are not in use. Close valves before refueling and immediately in an emergency.

Be sure appliance valves are closed before opening cylinder valve.

Test the LPG system for leakage before use. Test all connections for leakage by means of the following:

- Before each use, close appliance valves, open LPG cylinder valve, allow indicated gauge pressure to stabilize close LPG cylinder valve, observe pressure gauge reading near cylinder valve for three minutes, pressure gauge reading should remain constant if no leak in the system is present, **If pressure gauge reading falls, leak is present: do not use LPG appliances;**
- Routine observation of bubble leak detector (if fitted); or
- Manual leak testing with foam-producing, soapy water or detergent solutions (with appliance burner valves closed and cylinder and system valves open); foam-producing solutions for leak detection on gas installations in accordance with EN 14291 meet these requirements;

☐ If you at all suspect that you have gas in the boat, open all hatches, DO NOT smoke or use open flame and avoid sparks from electric switches until you are sure that the boat is free from gas. If leakage is present, close cylinder valve and have the system repaired before further use, system repairs should be made by a competent person.

CAUTION — Do not use solutions containing ammonia.

WARNING — Never use flame to check for leaks.

WARNING — Fuel burning open flame appliances consume cabin oxygen and release products of combustion into the craft. Ventilation is required when appliances are in use. Open designated vent openings while appliances are in use. Do not use the stove or oven for space heating. Never obstruct ventilation openings.

Do not obstruct access to LPG system components in any way.

Keep valves on empty cylinders closed and disconnected. Keep protective covers, caps or plugs in place. Store reserve cylinders in ventilated housings on open decks or in gas-tight lockers which are vented overboard and intended for that purpose.

Note !

Going to sea

Please ensure to secure loose equipment safely when underway.

Please be careful to check that the stove is well secured from its gimbaling position, in order to prevent the cover and stove colliding when sailing. (HR 310-HR 43)

Please also make sure that all portlights and skylights are well closed before going to sea. The magnetic door holders are designed to be used in harbour. If sailing in fresh wind, please always lock the doors in their frames, not with the magnetic door holders.

Openings in the hull

- Keep seacocks, cockpit drains, bungs and other opening/closing devices in the hull closed or open, as appropriate, to minimize the risk of flooding.
- Keep portlights, windows, washboard, doors, hatches or ventilation openings closed when appropriate, e.g. in rough weather.

Please do not store equipment containing petrol (outboard engines, tanks etc.) in compartments not designed for this purposeholders. That includes lockers that are not drained outboards but inboards.

Safety measurements to be taken to prevent gas leaks

Warning - highly explosive !

Always be careful using a stove - specially a gas stove.

DO NOT USE AN OPEN FLAME TO CHECK FOR LEAKS !

The stove flames consume oxygen and produce combustion gas. Ventilation is required when the stove is in use. Do not use the stove or oven to heat the boats interior. Do not cover the air vents in the accommodation hatch.

Do close both the valve at the stove and the valve at the bottle when you don't use the stove

Do not block the access to the valves neither on the stove nor on the bottles.

Keep valves on empty gas bottles closed and store spare as well as empty bottles in the intended compartment or on open deck.

Your stove and gas regulator is made for a certain pressure. Both stove and regulator is labelled with the pressure.

Do not change to other pressure on only regulator or stove. Stove and regulator **must** have the same pressure

Do not store other equipment in the gas bottle compartment.

Do not leave the boat unattended when the stove or oven is in use.

Do not smoke or use open flame unless you are completely sure that there is no LPG in the boat.

Do check the gas hoses and fittings regularly, at least once a year, to inspect if there is any kind of wear or damage. Put soap water on all connections as a leakage test. If any defect is found, the damaged part must be changed by a specialist before further use.

The compass

The compass is not compensated. The compensation can only be made by a professional compass adjuster and only after the yacht has been in the water, fully equipped, for at least three weeks. The compass must settle in its new magnetic surroundings. If you have chosen a chart plotter on top of the magnetic compass, the magnetic compass is only to be seen as an emergency solution. If you need more accurate reading of your magnetic compass, you temporarily need to remove the chart plotter from near the compass. The autopilot's fluxgate compass is located elsewhere and is not affected by the chart plotter.

The winches

Warning

Always have control over the sheets that are not in use.

Always be careful using the winches. Keep children away.

Only el. winches: Never take off the cover of the control button!

Have in mind that the buttons may have a malfunction and do not lift a human with a powered winch using selftailing. If you don't use the selftailing with the powered winch, you can ease the sheet a little in case the button should not cut off as it should. Also, switch the switches off for electric and hydraulic winches and furling, when you don't use those functions.

Do not underestimate the need for cleaning and greasing the winches. Sea water, rain and wash water enters especially the anchor windlass and the mast winches. Beware, don't wait too long, risking that the drum won't move. A rule of thumb is: Do this when starting and in the middle of the season.

The Sprayhood

The dodgers will get soiled, in some areas so hard that only a regular wash will help. This must not be done in a washing machine but by hand in 36 degrees Celsius and the sprayhood will come out as good as new. Be careful with the zippers. Wash away salt deposits and lubricate, any grease will do. If neglected do not be surprised if it fails.

In recent years, many factors have contributed to the development of mould on outdoor marine solar protection:

- Increased air pollution.
- Increased restrictions on the use of certain chemicals in fabric treatments (fungicides – environmental standards).
- Increased window surface areas (by more than 50% during the past 5 years), considerably reducing ventilation (the crystal material is completely air-tight, unlike other materials).

Advice

- **As consistently as possible, clean your fabric on a monthly basis:** spraying with a hose or rubbing with a soft brush (such as one used on clothing) will eliminate most dirt. This will prevent the need for premature deep cleaning (generally recommended every 2 to 3 years depending on the environment).
- **Before folding or putting away your solar protection (biminis, sprayhoods etc.),** make sure it is completely dry and clean to avoid the formation of mould while in storage.
- **Avoid cooking under your solar protection (sprayhoods, biminis, etc.)** because smoke, gas fumes and steam from cooking contain micro-nutrients that can promote the formation and development of mould on the fabric.

- **Make sure to always keep your solar protection well ventilated**, insufficient ventilation for evacuating accumulated interior moisture will encourage the development of mould (favourable threshold: over 65% humidity). Above all, do not cover your solar protection with a totally airtight PVC tarpaulin or obstruct lateral ventilation screens that maintain proper ventilation.
- **Do not use solvents**, detergents or abrasives, or clean your fabric with a high pressure machine or a washing machine.

If your fabric has a few wrinkles, you can iron it, but only using the synthetic/delicate fabric setting (do not use any steam whatsoever).

Quick basic cleaning

- Brush the fabric to remove surface dirt.
- Spray the fabric with cold water.
- Prepare a mixture of soap and water.
- Rub the mixture onto the fabric with a soft brush.
- Allow the mixture to act on the fabric.
- Rinse thoroughly with plain water until the cleaning solution is completely removed.
- Allow the fabric to dry in the open air.

More intensive cleaning of canvas fabric to get rid of mould

- Prepare a solution with 1/10 bleach, 2/10 soap, 7/10 water.
- Scrub the fabric with the solution and a soft brush.
- Allow the solution to act for 15 minutes.
- Remove the solution using a sponge or a clean towel.
- Rinse thoroughly with plain water.
- Allow the fabric to dry in the open air.
- It is essential to use a mould-proofing treatment to restore the fabric's original waterproof properties.

Warning!

When going astern, please make sure you are holding the wheel or tiller firmly with your hands! The rudder will give a huge kick to the wheel/tiller when going astern and if you do not hold the wheel or tiller well, damages will occur to the steering system.

Wheel steering

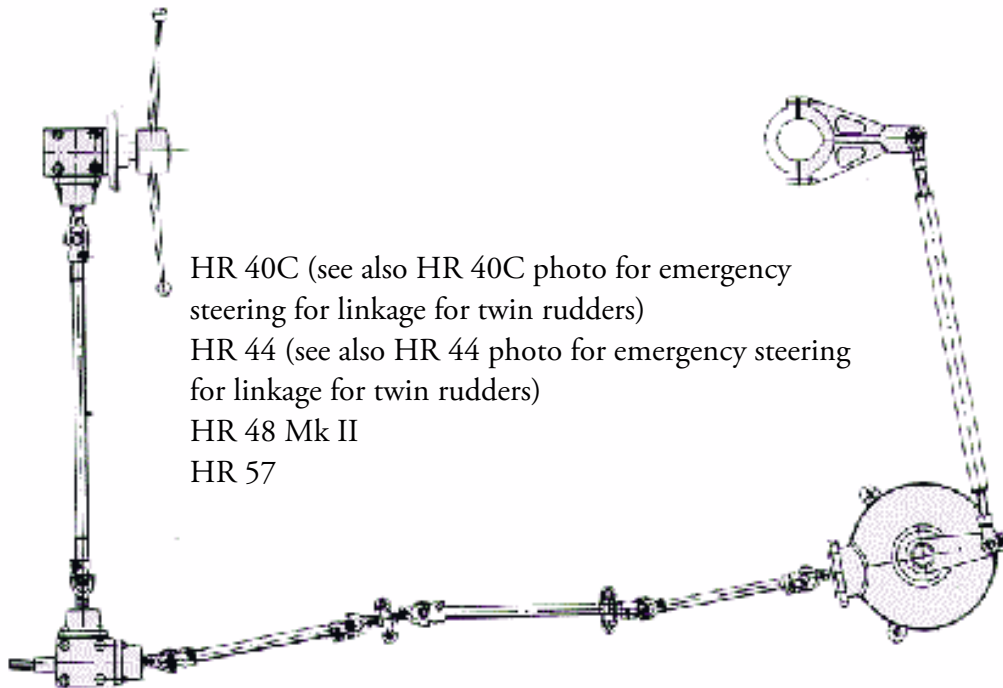

HR 40C (see also HR 40C photo for emergency steering for linkage for twin rudders)

HR 44 (see also HR 44 photo for emergency steering for linkage for twin rudders)

HR 48 Mk II

HR 57



HR 310 with wheel steering

HR 372

HR 412

Steering system Hallberg-Rassy 310

Warning!

The bronze fitting that is bolted to the rudder shaft is holding the rudder in place. Before you remove the bronze fitting the boat has to be lifted out of the water. The rudder has to be secured with supports in order to prevent it from falling out.

Make sure that the horizontal bolt to the right in the picture below is well tightened. It is a clamping bolt so sufficient tension is essential for proper function



Hallberg-Rassy 310 upper rudder shaft fitting

The emergency steering

The emergency tiller may be connected to the rudder shaft directly. If you have an autopilot with drive directly on the steering quadrant, the autopilot will also work as an additional emergency steering. Centre cockpit boats have tackles, aft cockpit boats have no tackles.

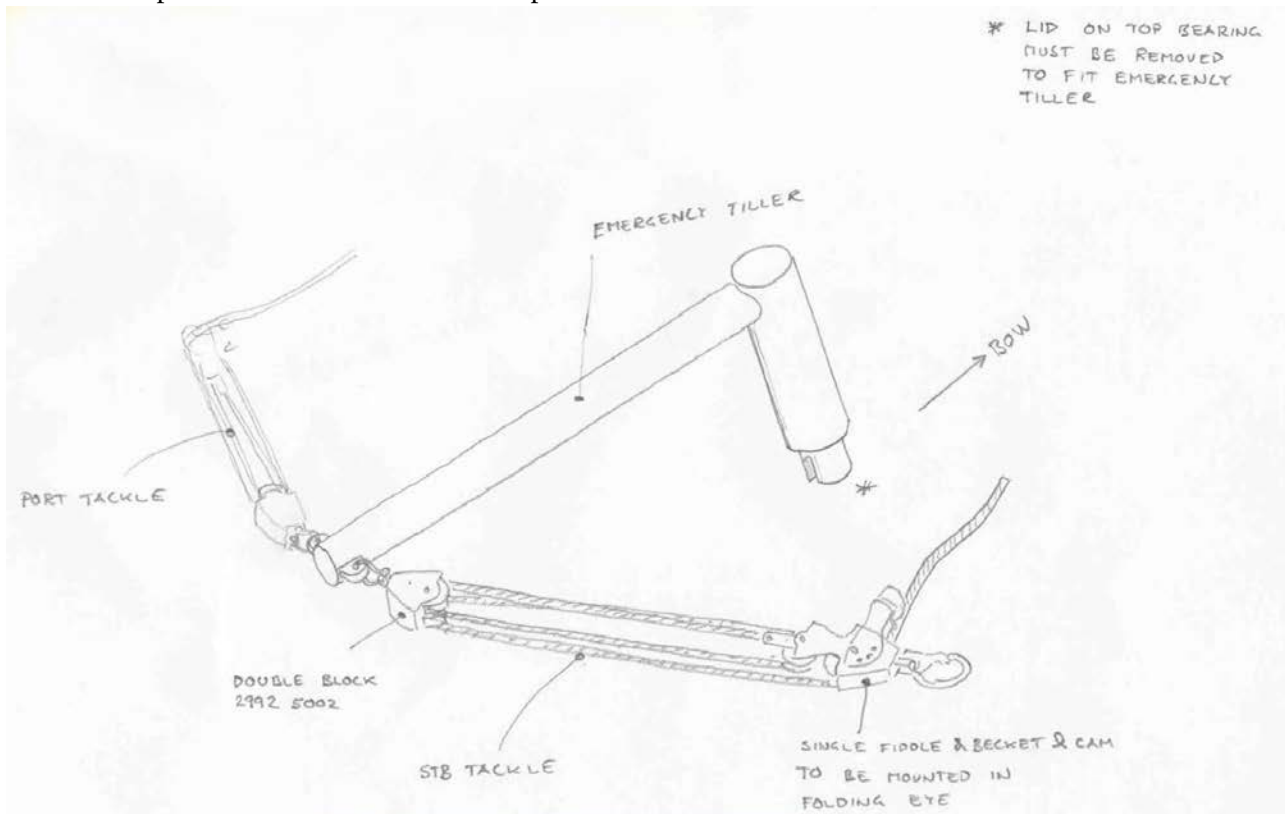

The emergency steering on the Hallberg-Rassy 40C and 44 consists of two tackles to be connected to eyes of the steering system in the aft cabin as per below photo.

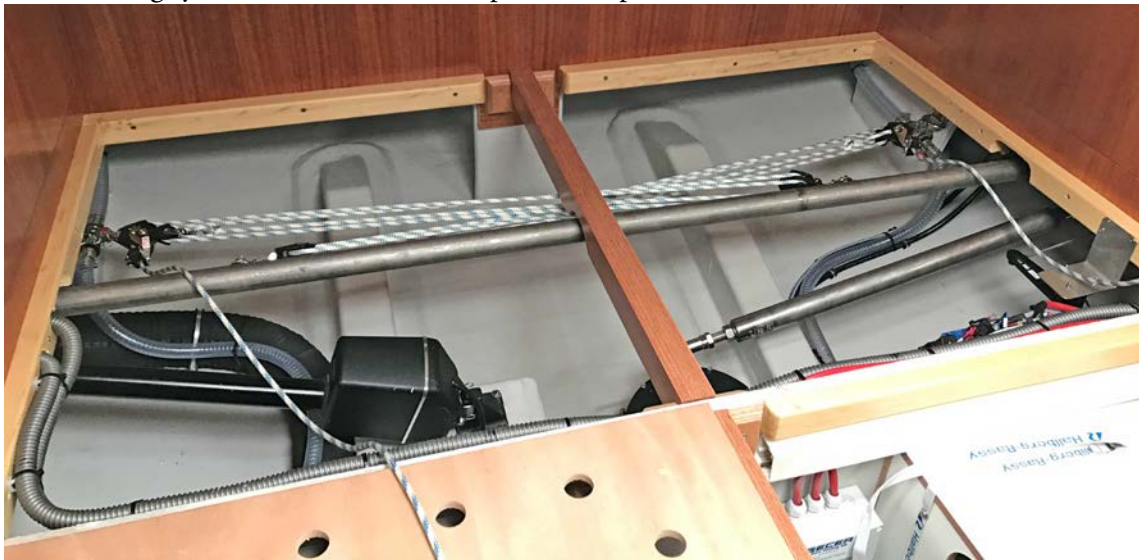

The emergency steering tiller location

The location of the emergency tiller is as follows:

HR 310, 340, 372, and 412: in the cockpit locker. HR 40C, 44 and 48 Mk II: under the aft berth. HR 57 and HR 64: in the big aft locker.

Autopilot

See manufacturer's manual.

If manual setting is possible, avoid a hasty operation, especially in heavy sea or when the boat is rolling to a swell in light wind. It is also recommended that the bolts securing the telescopic cylinder is checked after some time.

Electronic instruments

Especially the speedometer/log but also the echo sounders, wind instruments and other electronics should be calibrated. This can only be done after the boat has been in use for some time. The first calibration is made by the yard. This is, however, only possible to do roughly. For best accuracy: check it later again.

How calibration is done is described in the manual for each particular instrument.

It is, more important to know the actual difference than to have it calibrated correctly.

Don't forget that currents and tide have more influence than an eventual incorrect calibration of the log.

Fenders

Warning

The filling valve should always be at the end pointing down.

This way it will not cause any injury in case it should pop out, due to heavy pressure in the fender.

The ideal stow away place for the fenders is forward in the chain locker. Make sure the fender lines are pointing forward, to prevent them being drawn into the chain pipe when the anchor chain runs out.

Have in mind not to hang a fender over the heater exhaust. The exhaust would melt and puncture the fender.

The gelcoat surfaces

The gelcoat is affected by sun and by aggressive dirt from air pollution and will lose its gloss. Therefore regular washing is preferable. Liquid soap is recommended, gelcoat cleaners and wax too. The cleaner will help to preserve the clear, light gelcoat colour and the wax will help to keep the dirt off.

It can hardly be avoided that dull spots will develop on the topsides where the fenders have rubbed. These can easily be removed by using rubbing compound which is available with finer or coarser grit at the yacht chandler. If needed you can use a slow rotating grinder with a lambskin pad.

It's all based on the same ideas as in car maintenance.

The teak deck

The teak deck is a part of your boats character. After a few weeks the teak will turn greyish, and a smooth silvery grey deck is probably what most people like to see. The reality is often something quite different.

You have probably already seen dark, dirty, sometimes mildewy teak decks. Mildew is something that is more frequent today than some decades ago. You will find it not only on teak decks. It can be found on concrete, piers, painted surfaces and so on. The presence might differ very locally, some areas suffer a lot from mildew, and others are not hit at all. In the long run the best way to treat the teak deck against mildew is to use Boracol. Boracol is a liquid that is uncoloured and thin like water. It is sold in normal chemist shops and hardware dealers. It is marketed as a treatment against mildew for garden furniture. Use a normal paintbrush and paint the deck with Boracol. Never use a normal brush on the teak! Do the work on a dry day. If it rains too much Boracol will be washed away. It does not matter if it is drizzling the next day but if it rains the complete day or over splashing waves washes over the deck, the Boracol will make no effect. That would flush the Boracol way too early. If it does not rain, spray the deck a little with water. This little amount of water only helps the Boracol to penetrate into the teak. After three to seven days you wash the deck with a sponge and cleaner, for example green soap. Please do not be afraid if you do not see any positive result immediately. On the contrary, the deck looks worse than it did before the treatment. After about ten days things will start to happen. The mildew has disappeared and the deck is clean. The mildew will not recur for some time. Do not be afraid to repeat the treatment now and then.



Environment protection

Don't use abrasive detergents and avoid using more than necessary.

Our recommendation is:

Wash regularly , if needed, once in a while with oxalic acid or sodium hypochlorite. Use a rag on the brush or a sponge to spare the soft part of the wood fibres, to minimise the wear.

You can also use fine-grained sandpaper. This will, if used lightly, only take off the tops. The brown areas that appear will soon fade, bleached by the sun. The amount of wood removed by light hand sanding is so small that it hardly matters.

The worst thing that can happen to a teak deck is cleaning it with a **high pressure water jet**. Every marina or yacht yard has such an equipment and there are definite reasons to **strongly advise against the use of this** on your teak deck. It's only a matter of seconds before deep grooves are made, or even splitting the teak.

At every boat show we meet people claiming that their high pressure cleaner with the right setting will clean a teak deck without damaging the wood. Do **not** believe them.

Oiled teak



Environment protection

Take care of left over oils and brushes .Use the intended containers .

There is no doubt about the fact that oiling the teak will prevent dirt from soaking in and that it will stabilise the softer fibres. Teak oil is good, but the result is seldom beautiful. Some teak oils encourage the development of mildew. The risks can be avoided by using a well known brand. (I.e. Teaksealer from Hempel.)

Varnished teak or tillers

Many boat owners have the opinion that varnished teak should not be found on boats. This could be true, but it is no secret that you now and then come upon boats that fascinate you by their immaculate varnished teak.

Varnishing teakwood puts high demands on the varnish and the build up of layers, but also on maintenance. You must be prepared to do a lot more than usual, if you want to be happy with your varnished teak in the long run.

Naturally this is primarily valid for outside teak, i.e. cap rails and hand rails. The chart tables beside the accommodation hatch are considerably easier in this aspect. Also varnished tillers need to be at least annually re-varnished, or more often at damages.

Varnished teak surfaces that are damaged to a large extent must normally be redone from scratch.

Freezing is often a disaster for varnished exterior woodwork.

Antifouling paint



Environment protection

Notice the laws about using antifouling paint. Never throw away leftovers in a container.

All boats are sealed with two coats of Light Primer from Hempel below the waterline. On top of this antifouling.

Remember that the antifouling paint is formulated to dissolve and disappear as it protects the underwater surfaces from fouling.

Note !

We advise against sanding the gelcoat below the water line, and we are strongly against blasting. Blasting your underwater area may severely damage the good protection the underwaterbody has.

The carpets

Again and again it has been confirmed that a boat with carpets is easier to keep clean than one without.

Dirt and dust will unavoidably collect on the carpet, but it's easy to keep clean with a vacuum cleaner.

If you get spots on the carpet it's mostly a question of oil or grease.

These spots are easiest removed with a clean cloth soaked with acetone. Do not wash the carpet with water, but use special carpet cleaning foam.

If your carpet has gone wet in the boat, it is important to dry it from both sides, and not to leave it to dry on the floor. If you leave it to dry on the floor, it will damage the rubber backside of the carpet, if your carpet has rubber backside.

Galley worktops

Your galley worktops are finished in composite stone materials. Please be advised that these are not made for being a cutting board and is not a suitable place to put something hot on. In case you get scratches, it is possible to sand out that.

Cleaning of the tanks, pipes and pumps

The cleaning of a water tank is best and easiest made with a sodium hypochlorite solution. This is available under several names but should contain only sodium hypochlorite (usually 4%) and declared suitable for water purification. Should the water smell bad or taste funny; follow up systematically and find out if it's present already in the tank or first in the pipes or the pump. Through experience we have found that it's practically always the plastic pipes or the pump. Only complete replacement will cure a bad case.

Electrolysis

Be watchful for eventual electrolysis.

It cannot be avoided on a boat that has different metals combined, which will invite electrolysis. Add to this the humidity, salty environment - and you have the ideal condition for electrolysis. Normally this gives no problem. Worse is if an electric cable is damaged in such a way that electric current can leak out, for example to the rudder shaft. Certain water qualities can be more harmful. Another thing that can happen is earth leakage from the shore connection that has a non-wanted influence on board. It can be recognised by a colour change in the antifouling or on other, often bronze, parts. In the worst cases irregular blooming can be seen. Whilst the corrosion by different metals and salt water is still rather limited, the consequences of electrolysis due to leaking current can get amazingly rapid and dangerous.

Be watchful! If you are in doubt, get in touch with the yard or a good technician.

Adjustment of hinges for locker doors



To adjust the hinge from side to side, use these two screws



To adjust the hinge up and down, use this screw

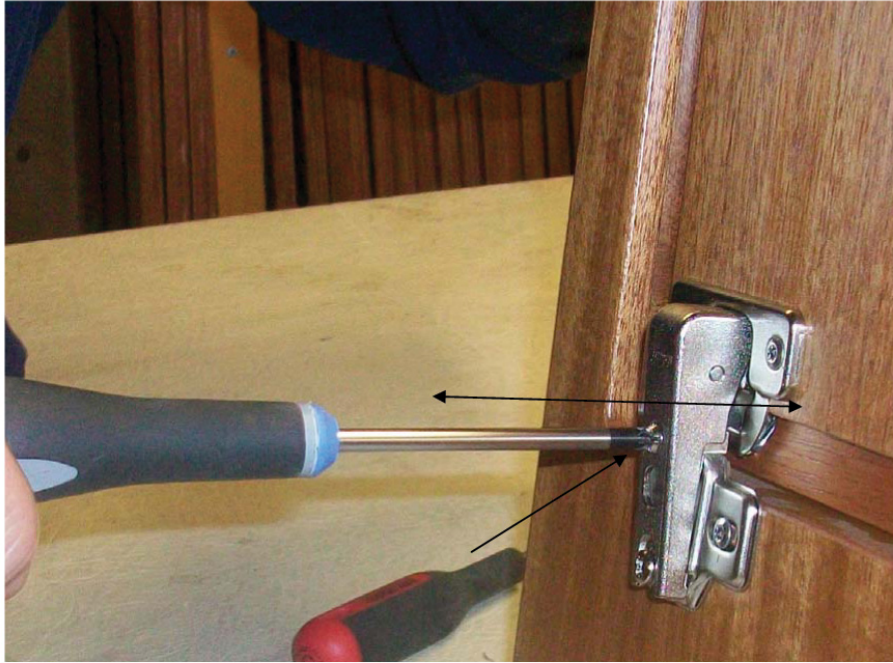

To adjust the hinge in and out, use this screw

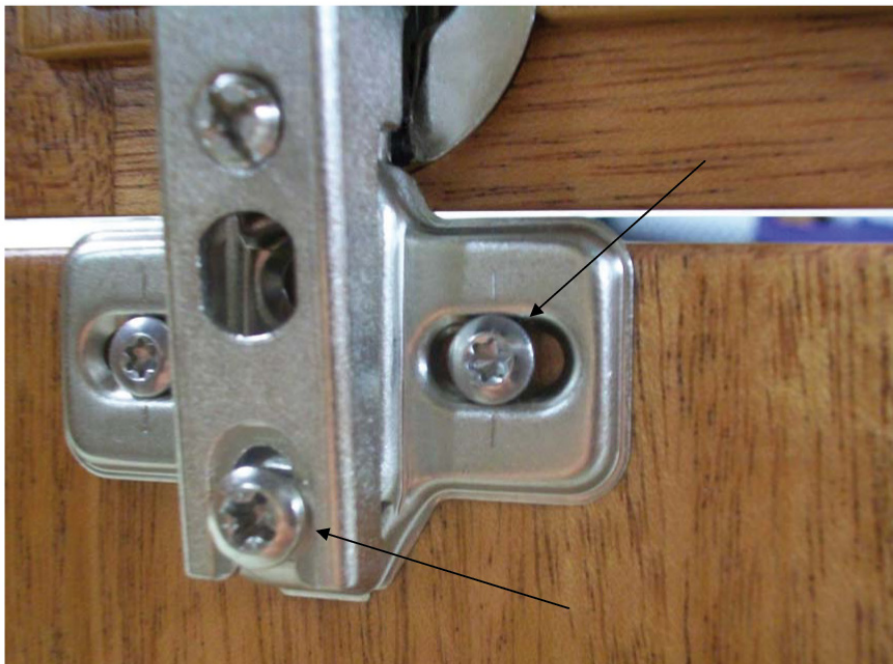

Two types of screws, Torx screws and cross headed screws



Screwdriver for cross headed screw



Screwdriver for Torx screw

Lifting and supporting ashore

Please note that weight figures given in this manual are for an empty standard boat with empty water- and fuel tanks. The individual boats are not weighed. For this reason the weight figures are approximate. If lifting by crane, ensure that it has a safe over-capacity for extra equipment, personal equipment tank contents and more.

All **Hallberg-Rassy** yachts are designed to stand safely on the keel, supported on two cross beams under the keel. The hull laminate is so dimensioned that load from the keel when resting in winter storing ashore will not cause any damage. The foremost beam under the keel should be placed as far forward as possible. It is also important that these supports do not compress over the time of storage. If the supports under the keel compresses, that will lead to too much load on the side supports with a high risk of damaging the hull laminate in that area. The four side supports are to be onto the hull, but at the same time not to put pressure onto the hull. The side supports have to be at least 25 x 25 cm for boats 31-37 ft and 30 x 30 cm on yachts over 37 ft. The supporting area towards the hull shall not be just a flat surface but covered with rubber or carpet, so that these shape after the hull shape, thus distributing the possible loads over a larger area. At least on yachts 31-37 there additionally need to be a forward and aft support This in order to prevent that the boat may fall forward or aft due to the weight of people moving on deck, but also to distribute vertical loads from the side supports. Forward and aft supports are to be dimensioned as the side supports.

Danger !

All lifting and slipping, especially of sail boats involve risks of life and must be made by competent people.

Details of the keel configuration and the best positioning of the slings are found on attached sketch. If the boat is lifted by crane in slings, these must be very long or spread out by bars, to eliminate heavy load on the cap rails. As always, the person who lifts the boat need to ensure that the slings are positioned in such a way that the slings do no come in conflict with any vulnerable parts of the boat.

Radar pole lift

The maximum static load is 60 kg. Static means that if the goods starts to move, it is less than 60 kg. The radar pole lift is definitely not intended for man over board recovery.

These sketches can just be seen as a rough guidance, since the distance of the slings, depending on the design of each individual crane, affects where to best put the slings.

Space for life raft

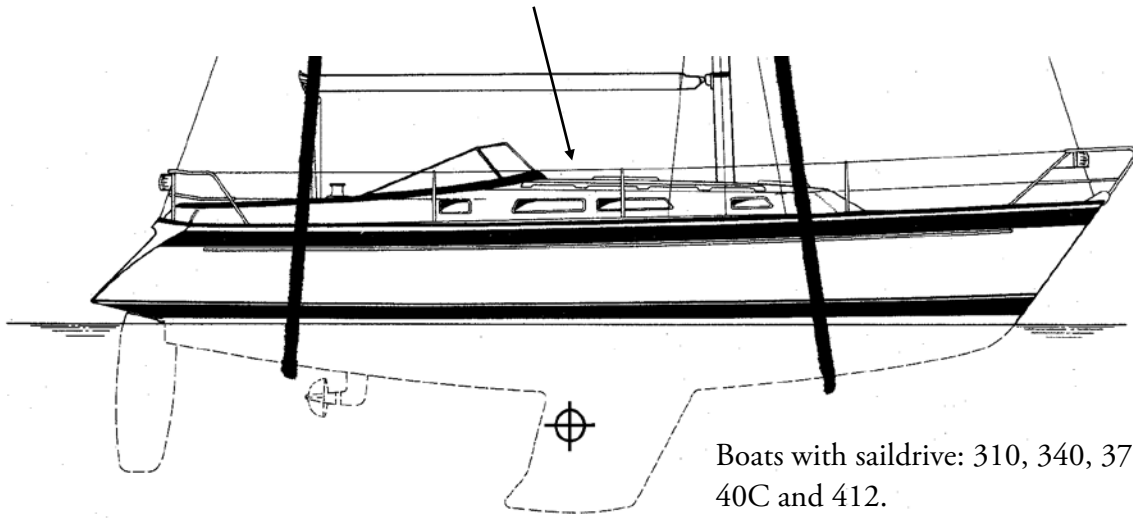

Boats with saildrive: 310, 340, 372, 40C and 412.

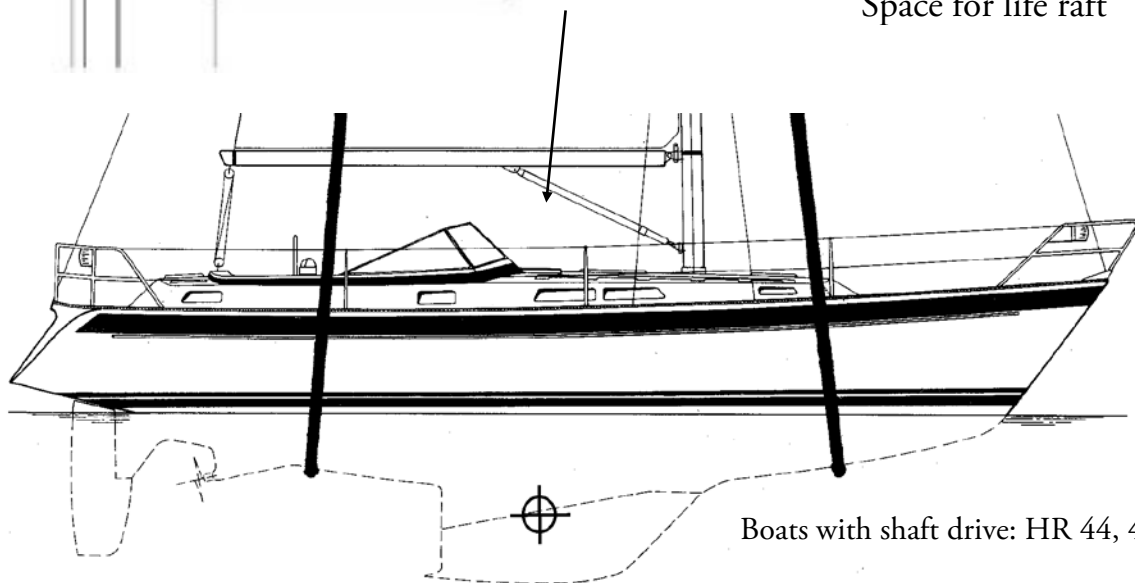
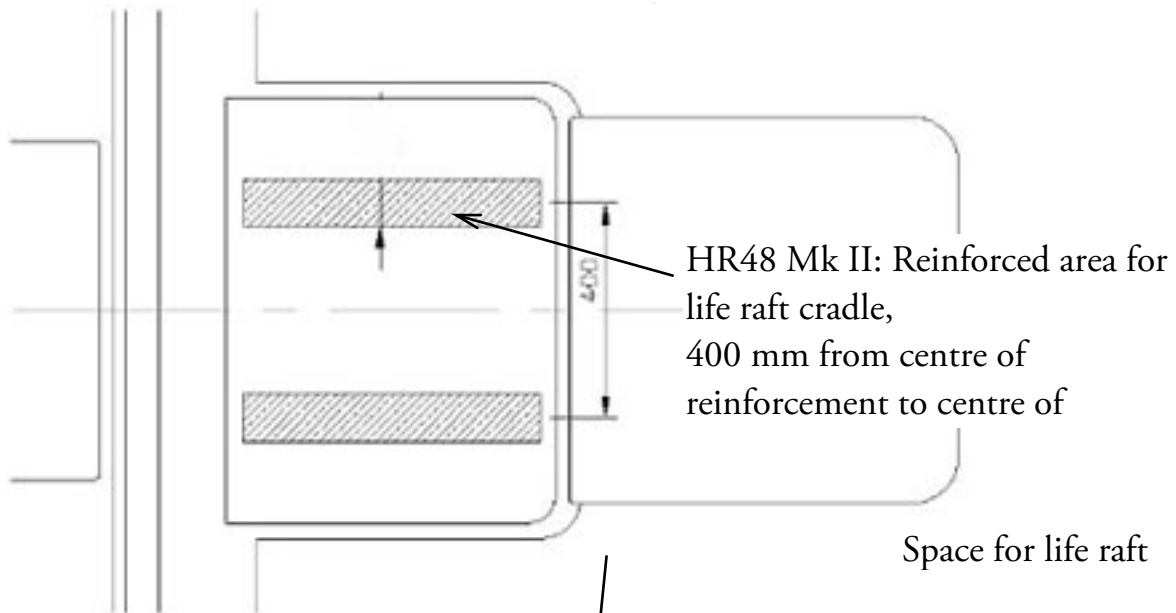

Boats with shaft drive: HR 44, 48, 57, 64

Risk of freezing

The risk of damage from freezing is less in the water than on land. In the water the boat will survive short spells with minus 5° C without problems. This is however not valid if you have a thermostat mixer for the shower armature. It will freeze and burst at only a few degrees below 0°.

If your boat is stored on land everything is different. If there is the slightest risk of frost, all measures must be taken to prevent damage from freezing. The secondary cooling water system of the engines (also the generator) should be checked regarding anti freezer.

The skin fittings

See the following pages.

Every skin fitting under the waterline has a ball valve on the inside. These require no greasing or maintenance. All valves should be operated now and then. In freezing conditions they should be left open.

Our advice is to knock on the through hull fittings with a hammer and a screwdriver once a year. If the metal is porous it is time for changing, if it is not porous, we see no reason to do anything at all, regardless of age.

Note !

Hose clamps should NOT be tightened more than necessary, and under no circumstances with your full strength.

Hallberg-Rassy 310 Standard

Through hull fittings overview

Divergence due to extra equipment can occur

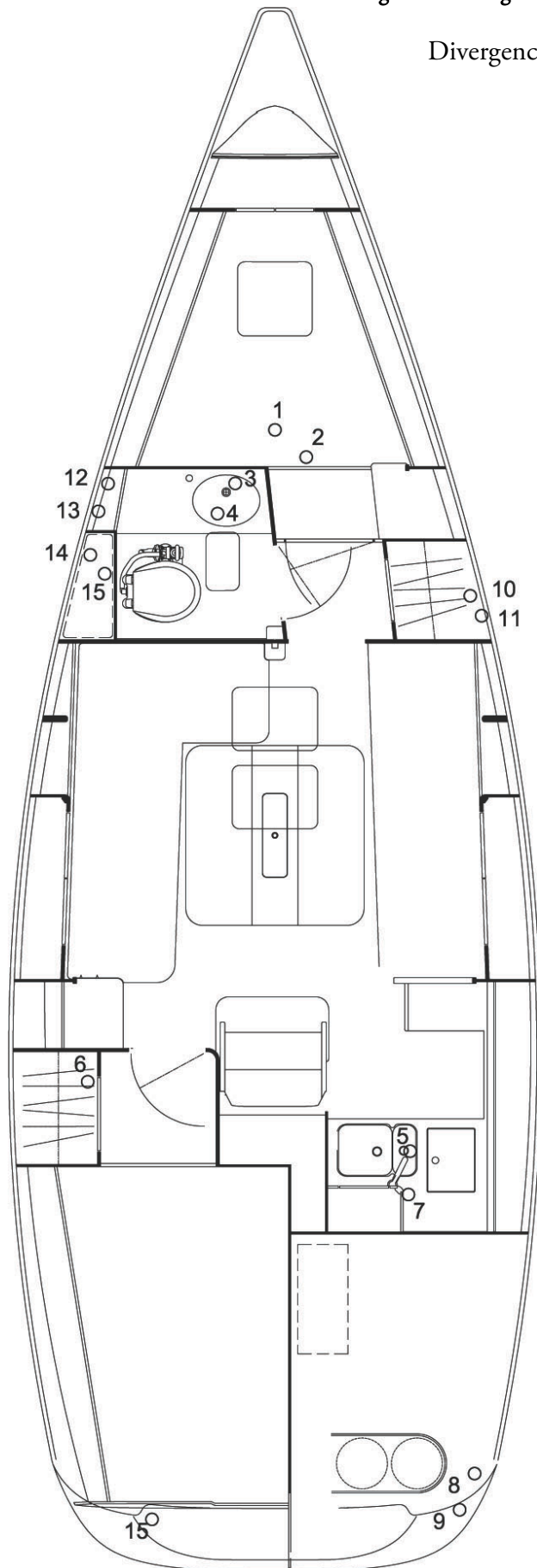

- 1= Speed/depth transducer
- 2= Toilet in
- 3= Sink in WC room out
- 4= Toilet out
- 5= Galley sink out
- 6= Deck drain port side
- 7= Deck drain starboard side
- 8= Bilge pump out
- 9= Exhaust outlet
- 10= Breather fuel tank
- 11= Emergency bilge pump out
- 12= Shower waste pump out*
- 13= Holdingtank breather
- 14= Fresh water tank breather
- 15= Battery box breather

*=Not standard equipment

Hallberg-Rassy 340

Through hull fittings overview

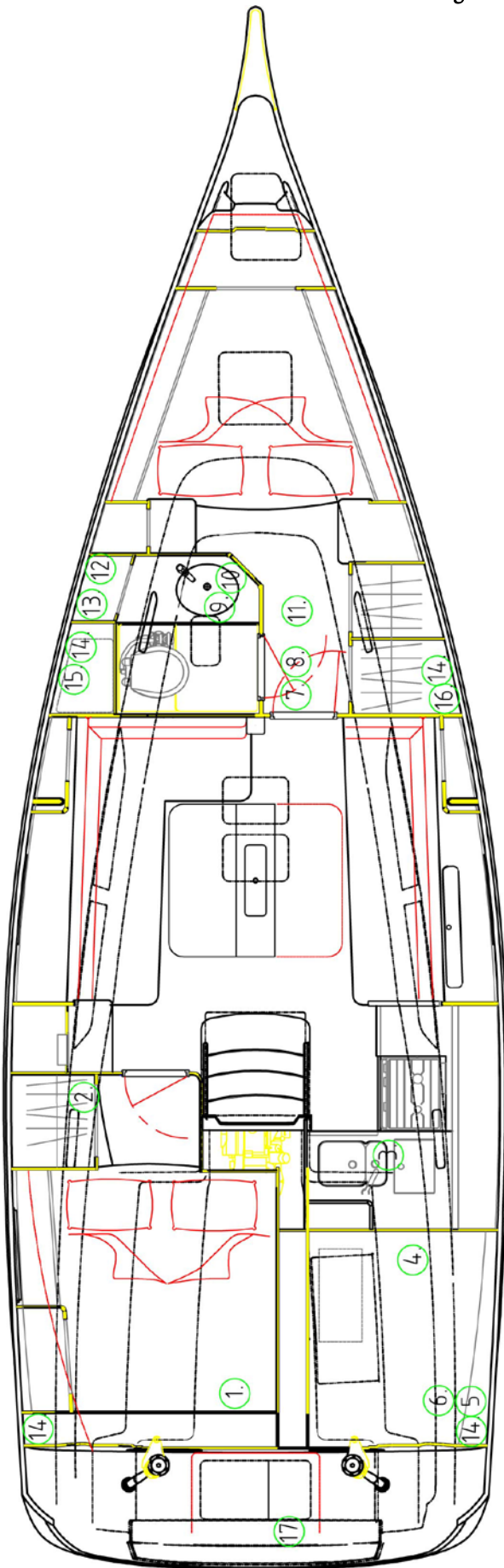

- 1 Deck drain aft port side
- 2 Deck drain mid port side
- 3 Galley sink/water cooled fridge
- 4 Deck drain mid and aft starboard
- 5 Emergency bilge pump
- 6 Bilge pump
- 7 WC in
- 8 Deckhatch drain
- 9 WC out
- 10 Sink out
- 11 Deck flush pump in
- 12 Shower waste water out
- 13 Breather black water tank
- 14 Battery vents
- 15 Freshwater tank breather
- 16 Fuel tank breather
- 17 Gas bottle locker drain

Hallberg-Rassy 372 Standard

Through hull fittings overview

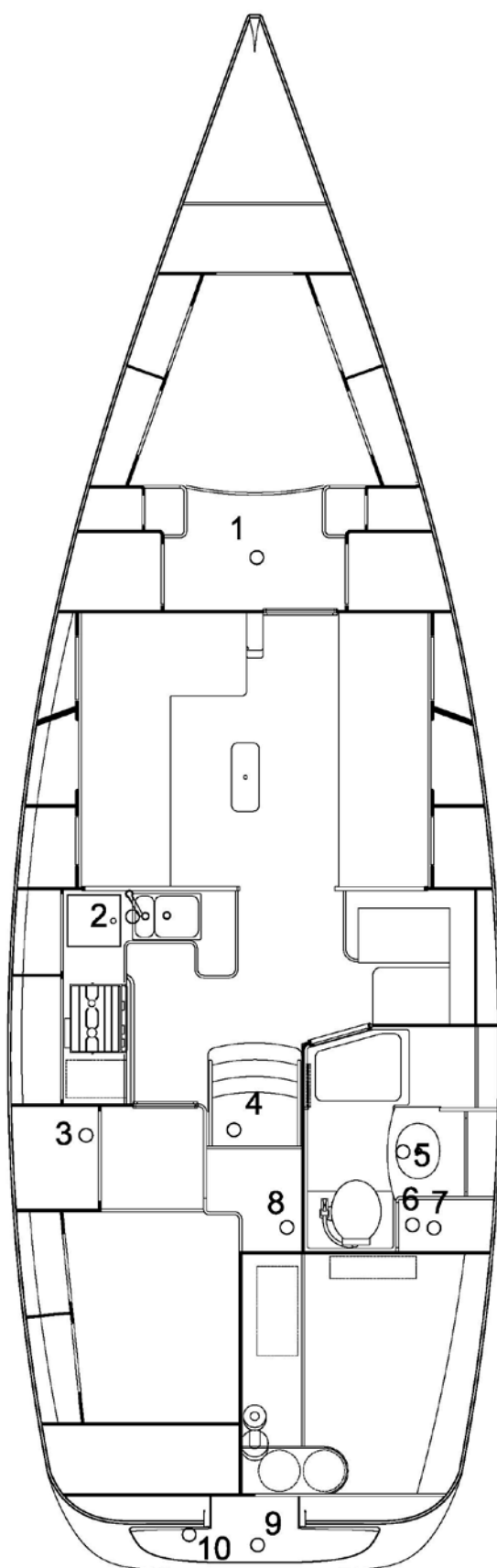

- 1= Speed/depth transducer
- 2= Galley sink out
- 3= Deck drain
- 4= Saildrive cooling water intake
- 5= Sink outlet heads
- 6= Toilet out
- 7= Deck drain
- 8= Toilet flush water in
- 9= Gas bottle locker drain
- 10= Port and sb cockpit locker drain

Hallberg-Rassy 412

Through hull fittings overview

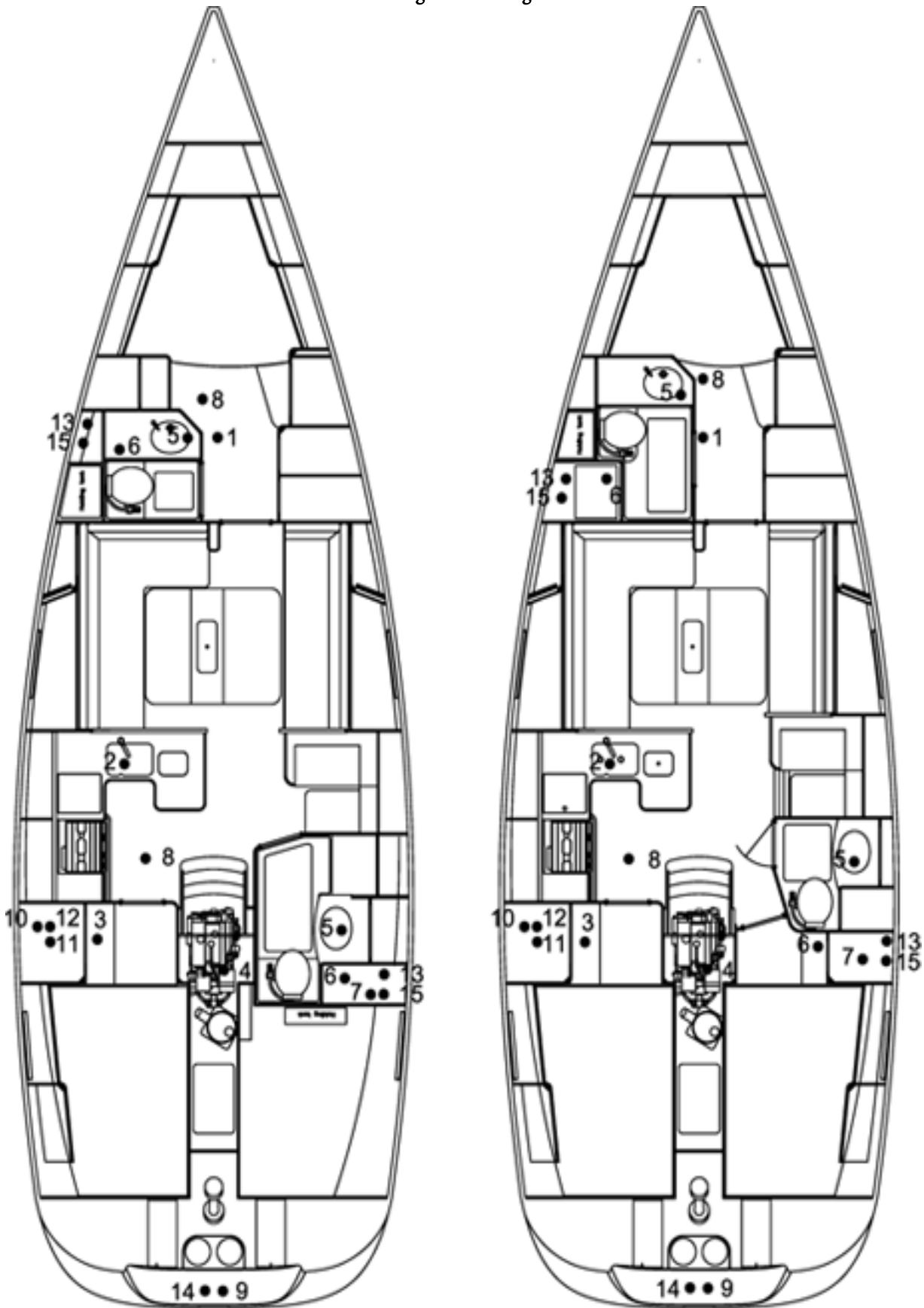

Continued on next page

Hallberg-Rassy 412

Through hull fittings overview

- ① SPEED/DEPTH
- ② SINK
- ③ PORT DECKDRAINAGE
- ④ INLET SAILDRIVE
- ⑤ WASHBASIN
- ⑥ TOILET/HOLDINGTANK OUT
- ⑦ STB DECKDRAINAGE
- ⑧ TOILET IN
- ⑨ DRAINAGE COCKPIT LOCKERS
- ⑩ BILGE PUMP OUT (man)
- ⑪ BILGE PUMP OUT (aut), option
- ⑫ EMERGENCYBILGE PUMP OUT
- ⑬ BREATHER HOLDING TANK
- ⑭ DRAINAGE LPG-BOX
- ⑮ SHOWER PUMP OUT

Hallberg-Rassy 40C

Through hull fittings overview

Divergence due to extra equipment can occur

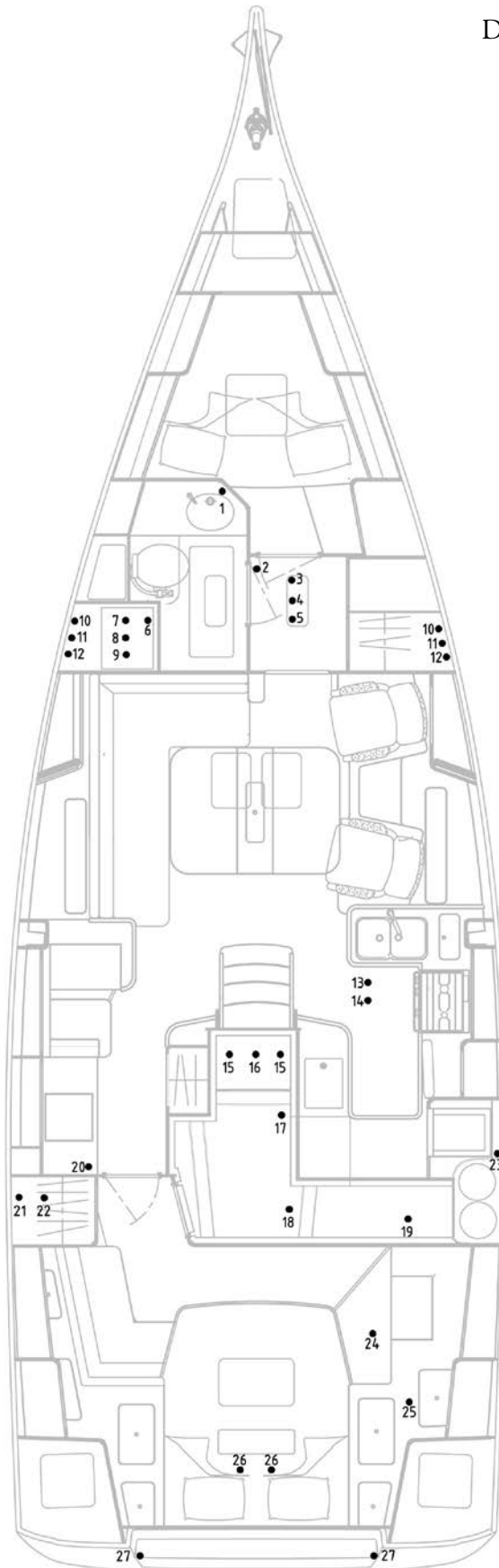

1. Outlet wash basin
2. Speed/Depth transducer
3. Inlet toilet
4. Inlet deck wash pump*
5. Deck hatch drain
6. Outlet toilet
7. Air vent holding tank
8. Outlet washing machine*
9. Outlet shower drain pump
10. Air vent fresh water tank
11. Air vent fuel tank
12. Air vent battery box
13. Outlet galley sink
14. Outlet galley sink
15. Cockpit drain
16. Inlet aux engine
17. Outlet:
 - Electric bilge pump
 - Siphon valve drain
 - Dishwasher*
 - Water heater safety valve
 - Air vent
18. Wet exhaust aux engine
19. Dry exhaust aux engine
20. Deck drain
21. Emergency bilge pump
22. Manual bilge pump
23. Exhaust heater*
24. Deck drain
25. Exhaust main engine
26. Deck stowage drain
27. Air vent battery

* = Extra equipment

Hallberg-Rassy 44

Through hull fittings overview

Divergence due to further options can occur

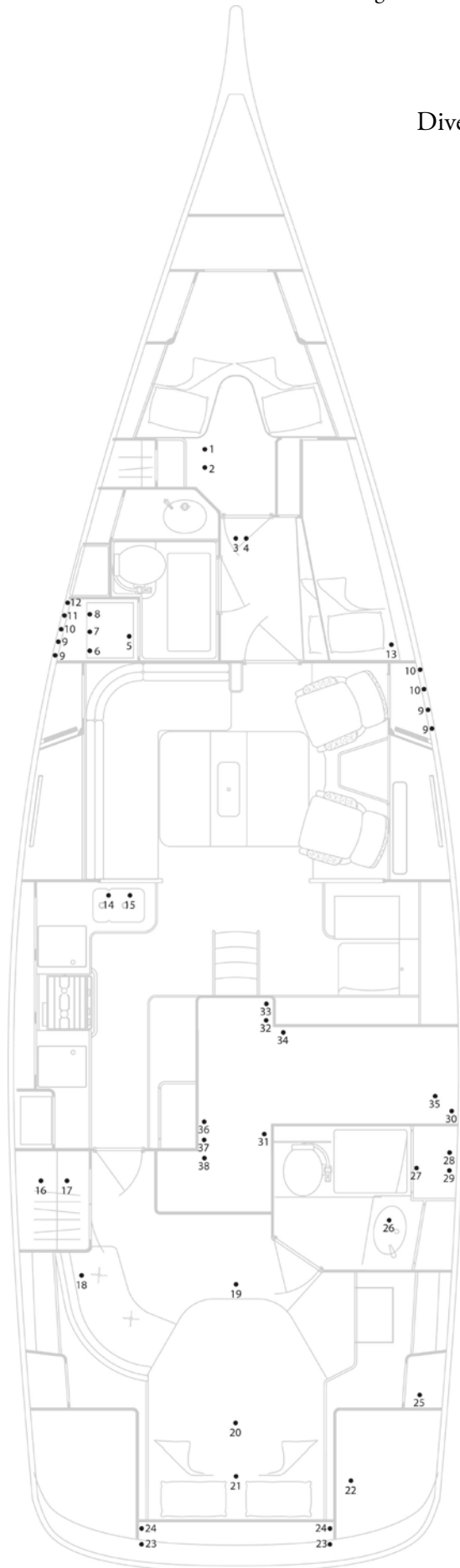

- 1 Deck hatch drain
- 2 Outlet basin
- 3 Speed/Depth
- 4 Inlet toilet
- 5 Outlet toilet
- 6 Outlet shower drain pump
- 7 Air vent. holding tank
- 8 Outlet washingmachine
- 9 Air vent. battery
- 10 Air vent. water tank
- 11 Air vent. diesel tank
- 12 Air vent. diesel tank
- 13 Outlet air conditioning
- 14 Outlet sink
- 15 Outlet sink
- 16 Manual bilge pump
- 17 Emergency bilge pump
- 18 Deck drain
- 19 Outlet Toilet
- 20 Deck Drain
- 21 Deck stowage drain
- 22 Exhaust main engine
- 23 Air vent. battery
- 24 Air vent. battery
- 25 Outlet air conditioning
- 26 Outlet basin
- 27 Deck drain
- 28 Air vent. holding tank
- 29 Outlet water maker
- 30 Exhaust heater
- 31 Inlet main engine
- 32 Cockpit drain
33. Outlet:
 - Electric bilge pump
 - Shower pump
 - Vacuum valve drain
 - Dishwasher
 - Air vent
- 34 Inlet aux. engine
- 35 Exhaust aux. engine
- 36 Inlet water maker
- 37 Inlet air conditioning
- 38 Inlet toilet

Hallberg-Rassy 48 Mk II Standard

Through hull fittings overview

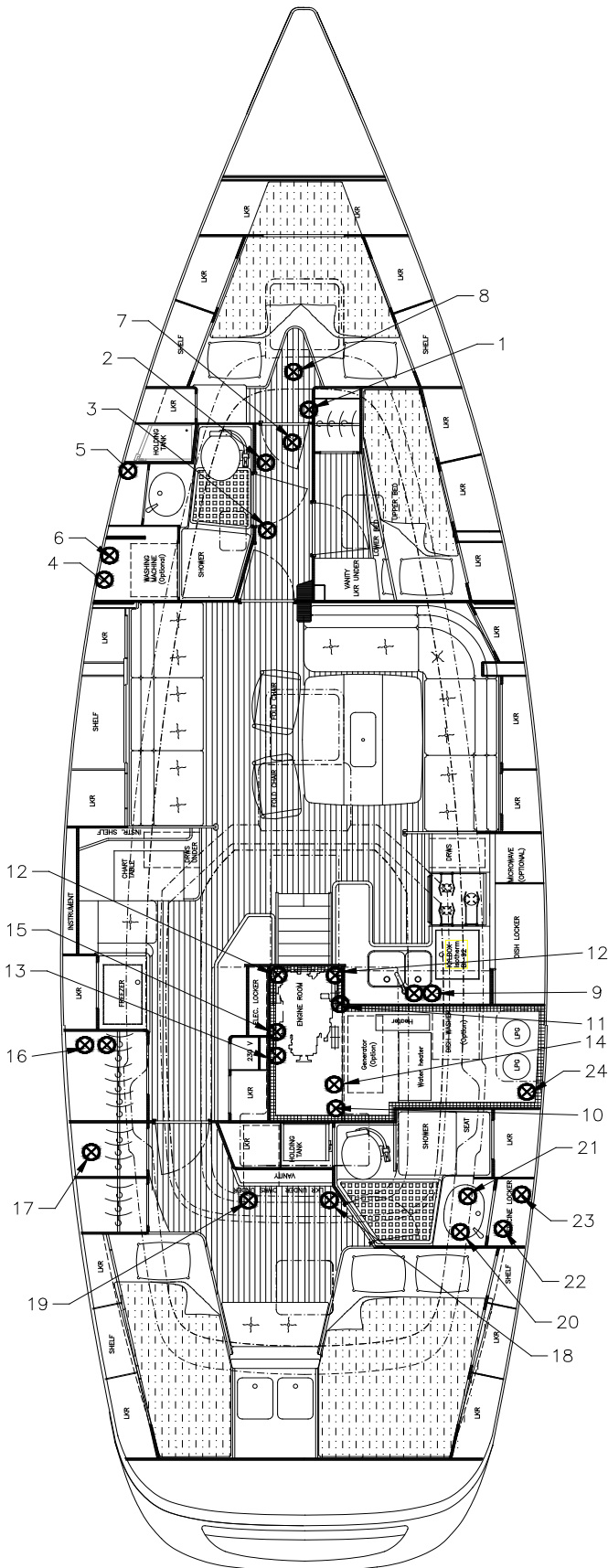

- 1= Inlet forward toilet
- 2= Outlet from forward toilet/holding tank
- 3= Outlet from sink
- 4= Outlet from shower waste water
- 5= Air intake forward holding tank
- 6= Outlet washing machine*
- 7= Speed transducer
- 8= Depth transducer
- 9= Outlet from sink galley
- 10= Cooling water intake main engine
- 11= Waterdivider generator*
- 12= Outlet cockpit drains (2pcs)
- 13= Inlet cooling water for AC* flusher 50litr*
- 14= Cooling water inlet generator*
- 15= Inlet watermaker*
- 16= Outlet from bilgepumps (emergency & manual)
- 17= Outlet deck drains port side
- 18= Outlet from aft toilet/holdingtank
- 19= Inlet aft toilet
- 20= Outlet from aft sink
- 21= Outlet deck drains starboard
- 22= Outlet from watermaker* AC out*
- 23= Outlet from shower waste water aft
- 24= Air intake aft holdingtank*

*=extra equipment

Hallberg-Rassy 57 Through hull fittings overview

Divergence due to extra equipment can occur

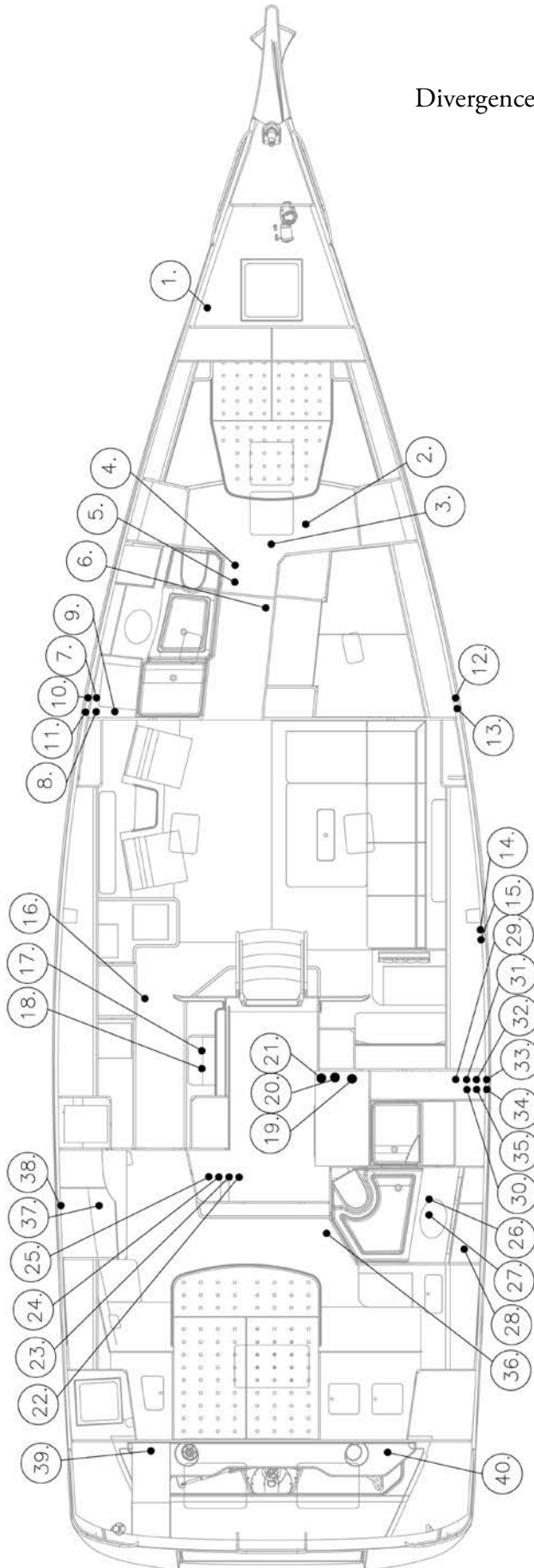

- 1= Outlet forward bilge pump
- 2= Inlet watermaker
- 3= Outlet forward skylight drain
- 4= Outlet toilet
- 5= Outlet was basin
- 6= Speed/depth transducer
- 7= Air vent holding tank
- 8= Outlet shower waste water
- 9= Outlet air condition
- 10= Air vent fuel tank
- 11= Air vent fuel tank
- 12= Air vent fresh water tank
- 13= Air vent fresh water tank
- 14= Outlet air condition
- 15= Outlet watermaker
- 16= Outlet deck drain
- 17= Outlet sink
- 18= Outlet sink
- 19= Outlet gen set
- 20= Inlet main engine
- 21= Outlet 2 x cockpit drain, electric bilge pump
- 22= Inlet gen set
- 23= Inlet main engine
- 24= Inlet air conditioning
- 25= Outlet deck drain, cockpit drain
- 26= Outlet wash basin
- 27= Outlet air condition
- 28= Outlet air condition
- 29= Exhaust gen set
- 30= Air vent holding tank
- 31= Outlet manual bilge pump
- 32= Outlet emergency bilge pump
- 33= Heater exhaust
- 34= Heater exhaust
- 35= Air vent battery
- 36= Outlet toilet
- 37= Outlet deck drain, cockpit drain
- 38= Air vent battery
- 39= Outlet deck drain/deckhatch fenderbox
- 40= Outlet deck drain/deckhatch fenderbox

Hallberg-Rassy 64 Through hull fittings overview

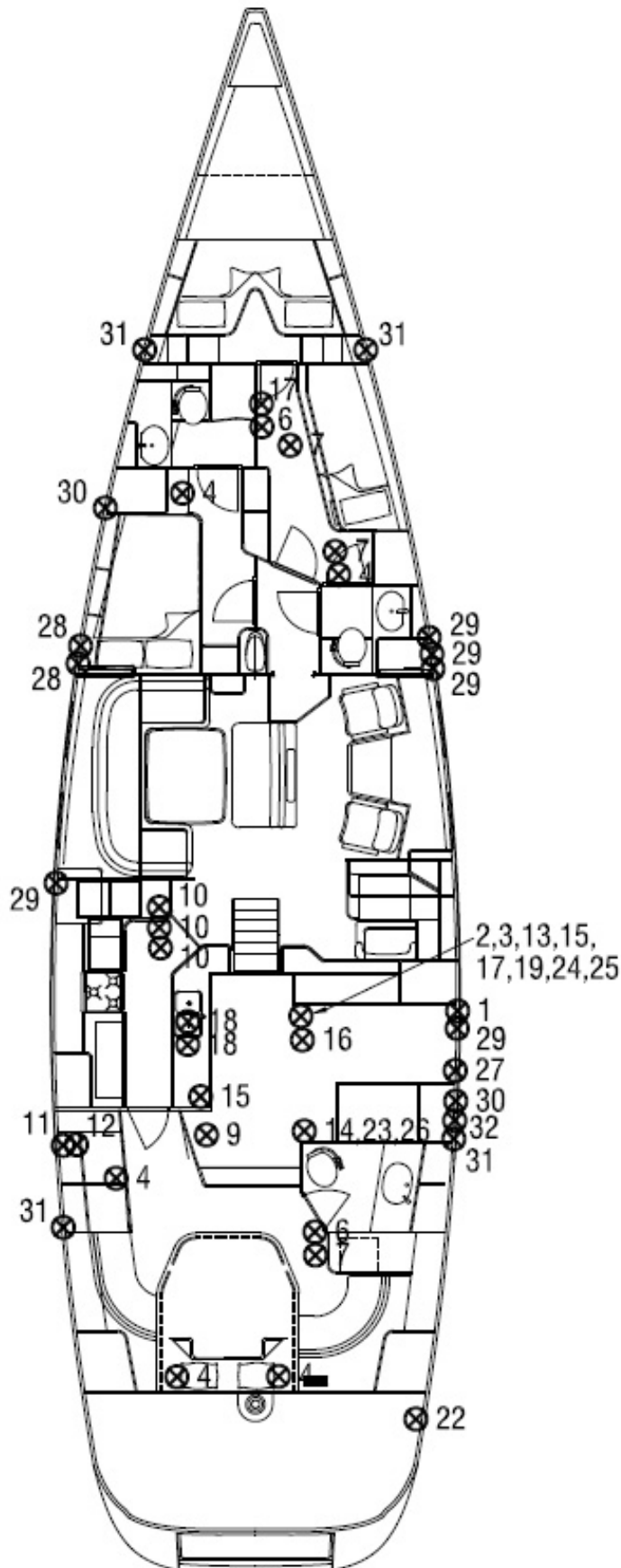

- 1= Exhaust diesel generator
- 2= Outlet wash basin
- 3= Outlet shower drain pump
- 4= Skinfittings deck drainage
- 5= Outlet watermaker *
- 6= Outlet holdingtank
- 7= Outlet toilet
- 8= n/a
- 9= Seawater intake engine
- 10= Cooling compressors/deckrainage
- 11= Outlet emergency bilgepump
- 12= Outlet manual bilgepump
- 13= Outlet electrical bilgepump.
- 14= Water intake watermaker *
- 15= Cockpit drainage
- 16= Water intake diesel generator
- 17= Speed / depth transducer
- 18= Outlet sink
- 19= Outlet washing machine *
- 20= Outlet dishwasher *
- 21= Outlet optional grey water tank *
- 22= Exhaust main engine
- 23= Intake aircondition *
- 24= Drainage lazarette
- 25= Outlet aircondition *
- 26= Inlet flush pump
- 27=Exhaust heater *
- 28=Air vent water tank
- 29=Air vent fuel tank
- 30= Air vent holding tank
- 31= Air vent battery box
- 32= Air vent optional grey water tank *

* = Extra equipment

Lay up or longer stops

If the engine lies idle for more than two months it must be prepared. To run it in the harbour now and then is no advantage if it isn't possible to put a load on the engine so it will be thoroughly heated.

The 230 V shore connection should be left disconnected for longer stays. At least the flexible cable to the water heater should be unplugged. (Located in the engine room)

There is almost always a small potential difference between the earth lead and the true earth in the water inside. This can cause damage in the long run.

Note !

Some insurance companies claim that all skin fitting valves should be closed. **DO NOT CLOSE THE COCKPIT DRAINS.** In the event of rain it will only be a question of time before the water level in the cockpit is so high that the water will enter into the boat.

The water tank:

The water will maintain quite fresh for a long time if the tank is completely full. It should then be pumped out and refilled with fresh water when you return to the boat. Based on many years of experience we can say that special chemicals are not needed when the water is of good quality. Always taste and smell the offered water before filling. Be sceptical of water with a mossy smell. It may cause growth inside the tank.

Sometime the question of cleaning of the tank arises. There is no reason to rush, don't open the inspection hatches if you don't have a problem. But if you do open them, don't be alarmed if the inside looks far from clean. The same applies probably to the water pipes in your home as well.

A short list for winter preparation

Water tanks	Empty by pump
Water pipes	Drain at low point
Water pumps	Remove hose connection, run dry.
Water filter	Open and drain
Water heater	See the manual from the water heater manufacturer
Shower mixer	Remove and dismantle
Washing machine	Remove inlet hose and drain plug
Dish washer	Remove inlet hose and drain plug
Toilets	Remove drain plug, pump dry
Water maker	Remove the membrane unit and store free from frost For drainage of pump and filters see the manual.
Deck shower	See shower mixer
Sea water pump and pipes	Pump dry, drain
Engine and generator	See manufacturers manuals
Batteries	Best left on board. Check the level in all cells. Charge to full capacity after filling and remove the leads.
Heater	Run well before closing down and first thing in the spring
All ball valves, sea intake and drains	Open to avoid trapping water in valve
Ventilation	Provide good ventilation during lay up time also in lockers etc.

D A T A

	HR 310	HR 340	HR 372	HR40C	HR 412	HR 44	HR 48 Mk II	HR 57	HR 64
Designer	Germán Frers	Germán Frers	Germán Frers	Germán Frers	Germán Frers	Germán Frers	Germán Frers	Germán Frers	Germán Frers
CE category	A	A	A	A	A	A	A	A	A
Hull length, m	9.42	10.36	11.35	12.30	12.61	13.68	14.99	17.44	19.85
Waterline at rest, m	8.80	10.10	10.25	11.74	11.50	12.88	13.25	16.77	17.53
Beam, m	3.18	3.47	3.60	4.18	4.11	4.20	4.50	5.11	5.20
Draft, empty load, m	1.80*	1.90*	1.99*	1.92*	1.99*	2.10*	2.35*	2.43*	2.50
Deep bilge between hull and keel	yes	yes	yes	yes	yes	yes	yes	yes	yes
Headroom saloon, m	1.86	1.91	1.93	1.95	1.96	1.97	1.99	2.16	2.11
Headroom walk-through, m	-	-	-	1.90	-	1.92	1.91	2.05	2.11
Cockpit length, m	2.36	2.83	2.77	2.29	3.12	2.29	2.21	2.91	3.10
Displacement, empty standard boat, t	4.35	5.98	7.5	11	11.1	13.3	18.5	26.3	36
Lead keel, weight, t	1.68	2.3	2.9	3.65	4.0	5.3	7.75	9.75	12.7
Sail area with jib, sqm	47.2	63.7	73.2	81	88.3	109.6	123.4	151.3	188.1
Sail area with genoa, sqm	47.2	63.7	73.2	90.1	93.4	109.6	139	175.5	232
Engine, Volvo Penta	D1-30	D1-30	D2-60	D2-60	D2-75	D2-75	D3-110	D4-175	D6-300
Cylinder displacement	1.13	1.13	2.2	2.2	2.2	2.2	2.4	3.7	5.5
Max torque, Nm	72	72	135	135	213	213	342	538	669
Power kW/HP at crank shaft	21/29	21/29	44/60	44/60	55/75	55/75	81/110	129/175	221/300
Fresh water, liters	200	277	425	520	530	745	910	1 030	1 300
Diesel, litres	100	188	270	400	340	420	800	1 050	1 800
Maximum recommended load, kg	1 361	1 805	2 000	2 500	2 460	3 287	4 000	5 410	6 750
Total weight in fully load condition, kg	5 711	8 400	9 500	13 500	13 560	16 587	22 500	32 697	42 750
Air draft excluding antennas or Windex	14.35	16.42	17.80	19.75	19.65	21.60	21.75	26.90	27.40
Holding tank, l	50	85	70	82	82 fwd, 70 aft	82 fwd, 80 aft	77 fwd, 78 aft	120 fwd, 130 aft	138 fwd, 80 aft
Maximum persons	6	8	8	10	10	10	15	10	16

*= also available as a shallow draft version

Dear Reader!

We have tried to make this manual as easy to read as possible.

If you have ideas or suggestions on how to supplement this manual, please feel free to share them with us.

To fully enjoy the boat, you should try to familiarise yourself with it as much as possible.

We hope this manual will help.

We **would** like to take this opportunity to congratulate you to your new boat and hope that you will be able to spend the time you wish sailing.

Warranty

The warranty terms for your boat are found in the sales contract.



HALLBERG-RASSY VARVS AB

HALLBERG-RASSYVÄGEN 1

SE-474 31 ELLÖS

SWEDEN

TEL +46-(0)304-54 800

www.hallberg-rassy.com info@hallberg-rassy.se

Spare parts:

Hallberg-Rassy Parts AB

Hallberg-Rassyvägen 2

SE-474 31 Ellös

Sweden

Phone: +46- 304-54 990

shop.hallberg-rassy.com info@hr-parts.com

ARGENTINA: José Frers, Ruben Dario 3447, 1646 Victoria PBA, Argentina, Tel: 54-11-47 45 05 37

AUSTRALIA, NEW ZEALAND: DBY Boat Sales, Princes St Marina, 16 Princes St, Newport, Sydney NSW 2106. +61 2 9999 3311 sales@dbyboatsales.com.au

BULGARIA: Finninvest Ltd., Bogoridy St No 59, BG-8000 Bourgas. Tel +359 (0) 56 845 107. Mobile + 359 888 30 60 53 fininv@bs.spnet.net

CROATIA: More Ocean d.o.o. Smičiklasova 19 HR-10 000 Zagreb Tel +385 1 5509501 Mobile + 385 98 48 38 54 marko@moreocean.hr

FINLAND: Oy Helmarin Yachts AB, Tammistontie 256, FIN-20900 Turku. Tel +358 (0)2 2581 600, +358 (0) 400 520 454 lassi.hellman@helmarin.fi

FRANCE: LJB Marine, Rue de la Perruche, ZA des Minimes, FR-17000 La ROCHELLE. Tel : + 33 (0)5 46 52 19 52. info@ljb-marine.com

GERMANY: HALLBERG-RASSY DEUTSCHLAND GMBH, AN DER WIEK 7-15, DE-23730 NEUSTADT. TEL 04562-558648. info@hallberg-rassy.de

HOLLAND: NOVA YACHTING INT. BV, *Postal address:* Postbus 15, NL-4310 AA Bruinisse. info@nova-yachting.nl

Visiting address: Jachthaven Bruinisse, Jachthavenweg 72, NL-4311 NC Bruinisse. TEL +31-111-48 18 10.

ITALY: LIONS INT-YACHTS, VIA SALENTO 12, IT-00162 ROMA. TEL 06-44 23 75 37. lionsyachts@fastwebnet.it

JAPAN: Kaiwo Co., Ltd, Mr Aki Yabuki, 4-3 Shiraho, Kanazawa-ku, Yokohama, 236-0007 Tel: 81-45-773-0685 info@kaiwo.com

KOREA: Gin-A Co., Ltd., Dongbu Root Bldg Suite 912, Hwangsaed-ro 200 bungil 36, Bundang-gu, Seongnam-si, Gyeonggi-do 13595

Tel: +82-31-711-9681 yacht@gin-a.kr

RUSSIA: Jonacor Marine, Konstantinovsky pr., 1/24, 197110 St. Petersburg. Tel: +7 (812) 702 47 70, dmitry.samoylov@jonacor-marine.ru

SPAIN: OLMARINE, Port Ginesta - local 720, ES-08860 Les Borges de Sitges (Barcelona) Tel +34 620275011 info@olmarine.es

SWITZERLAND: BOOTSWERFT ROLF MÜLLER AG, BOTTIGHOFEN, CH-8574 LENGWIL. TEL 071-688 41 41. info@bootswerft-mueller.swiss

TURKEY: Galip Kaynar, PRIENE TURIZM VE YATCILIK LTD. STI., Tesvikiye Cad No 45/1 Nisantasi, TR-34367 Sisli, Istanbul.

Tel +90 212 2412241 galipkaynar@galipkaynar.com

UK: TRANSWORLD YACHTS SAILING LTD, HAMBLE POINT MARINA, SCHOOL LANE, HAMBLE, SOUTHAMPTON SO31 4JD.

TEL 023-8045 60 69. enq@transworld-yachts.co.uk

USA, MD: Free StateYachts, P O Box 220, Deale MD 20751 TEL410 86 79 022. sales@freestateyachts.com

USA, WA: WEST COAST YACHTS, 1800 WESTLAKE AVENUE NORTH, SUITE 201, SEATTLE, WA 98109. TEL 206-298-3724. info@westcoastyachts.us